

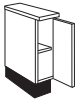

# HIGH LINE BASE UNITS

## HIGH LINE BASE UNITS

Model/Description	Product Code	Width	Depth Excluding Door
<b>High Line Base Unit 720mm High</b>			
 1 Door 1 Adjustable shelf	<b>B15</b> L or R (-) •	150mm	560mm   460mm(S)
 1 Door 1 Towel rail	<b>B15</b> L or R T2 •	150mm	560mm
 1 Door 1 Adjustable shelf	<b>B30</b> L or R (-)	300mm	560mm   460mm(S)
	<b>B40</b> L or R (-)	400mm	560mm   460mm(S)
	<b>B45</b> L or R (-)	450mm	560mm   460mm(S)
	<b>B50</b> L or R (-) •	500mm	560mm   460mm(S)
 2 Doors 1 Adjustable shelf	<b>B60</b> L or R (-) •	600mm	560mm   460mm(S)
	<b>B80</b> (-)	800mm	560mm   460mm(S)
	<b>B90</b> (-)	900mm	560mm   460mm(S)
	<b>B100</b> (-) •	1000mm	560mm   460mm(S)
 2 Doors 1 Adjustable shelf	<b>B120</b> (-) •	1200mm	560mm   460mm(S)
<b>High Line Base Unit with Internal Tray Space</b>			
 1 Door 1 Adjustable shelf 1 Tray space	<b>B45</b> L or R T1 (-)	450mm	560mm   460mm(S)
	<b>B50</b> L or R T1 (-) •	500mm	560mm   460mm(S)
	<b>B60</b> L or R T1 (-) •	600mm	560mm   460mm(S)
<b>High Line Base Unit with Internal Towel Rail</b>			
 1 Door 1 Adjustable shelf 1 Towel rail 1 Tray space	<b>B45</b> L or R T2	450mm	560mm
	<b>B50</b> L or R T2 •	500mm	560mm
	<b>B60</b> L or R T2 •	600mm	560mm
<b>High Line Base Breakfront Unit with 45° Front 720mm High</b> Right Hand version illustrated			
 1 Door Pull-out storage on runners Unit breaks back 290mm	<b>BBF30</b> L or R W1	300mm	560mm
 1 Door 1 Adjustable shelf Unit breaks back 290mm	<b>BBF30</b> L or R	300mm	560mm

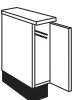
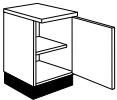
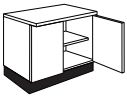
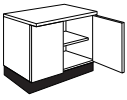
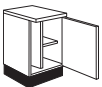
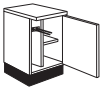
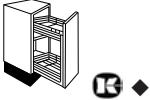
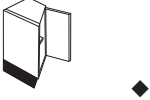

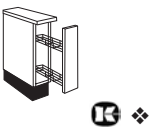
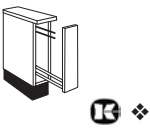
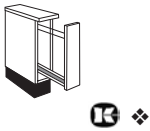
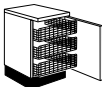
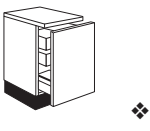
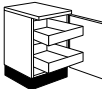
# HIGH LINE BASE UNITS

## HIGH LINE BASE UNITS

Model/Description	Product Code	Width	Depth Excluding Door
<b>High Line Base Unit with Pull-out Wirework 720mm High</b>			
 <p>1 Door Pull-out storage on runners (two wire baskets with solid bottoms) See page XXX for Stainless Steel option</p>	<b>B15 W7</b> •	150mm	560mm
 <p>1 Door 1 Pull-out towel rail</p>	<b>B15 W8</b> •	150mm	560mm
 <p>1 Door 1 Pull-out tray space</p>	<b>B15 W9</b> •	150mm	560mm
 <p>1 Door 3 x 140mm High vegetable baskets</p>	<b>B40 L or R W3</b>	400mm	560mm
	<b>B50 L or R W3</b> •	500mm	560mm
	<b>B60 L or R W3</b> •	600mm	560mm
<b>High Line Pull-out Base Unit</b>			
 <p>1 Pull-out pan drawer 2 Internal drawers</p>	<b>B30 P4</b>	300mm	560mm
	<b>B40 P4</b>	400mm	560mm
	<b>B45 P4</b>	450mm	560mm
	<b>B50 P4</b> •	500mm	560mm
	<b>B60 P4</b> •	600mm	560mm
<b>High Line Base Unit with Two Internal Drawers</b>			
 <p>2 Internal drawers</p>	<b>B30 L or R (-) P3</b>	300mm	560mm
	<b>B40 L or R (-) P3</b>	400mm	560mm
	<b>B45 L or R (-) P3</b>	450mm	560mm
	<b>B50 L or R (-) P3</b> •	500mm	560mm
	<b>B60 L or R (-) P3</b> •	600mm	560mm
<b>Base Unit with Pull-out Combi Waste Bin</b>			
 <p>1 Door 1 Pull-out waste bin</p>	<b>B30 L or RA1</b>	300mm	560mm

# HIGH LINE BASE UNITS

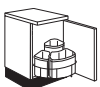
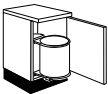
## HIGH LINE BASE UNITS

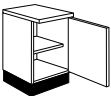
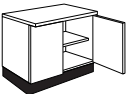
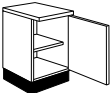
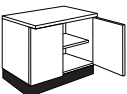
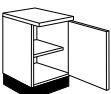
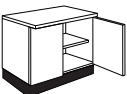
Model/Description	Product Code	Width	Depth Excluding Door
<b>Base Unit with Swing-out Combi Waste Bin</b>			
 <ul style="list-style-type: none"> <li>1 Door</li> <li>1 Swing out combi waste bin (Capacity 19L, 12L and 9L Total Capacity 40L)</li> </ul>	<b>B50 L or R A7</b> •	500mm	560mm
<b>Base Unit with Cylinder Waste Bin</b>			
 <ul style="list-style-type: none"> <li>1 Door</li> <li>1 Cylinder waste bin (Capacity 15L)</li> </ul>	<b>B40 L or R A2</b>	400mm	560mm
<b>Base Unit with Pull-out Waste Bin</b>			
 <ul style="list-style-type: none"> <li>1 Pull-out Door</li> <li>3 Loose Bins (Capacity 60L)</li> </ul>	<b>B45 A9</b>	450mm	560mm
	<b>B50 A9</b>	500mm	560mm
<b>Base Unit with Drip Tray</b>			
 <ul style="list-style-type: none"> <li>1 Door</li> <li>1 Adjustable shelf including drip tray</li> </ul>	<b>B50 L or R T</b> •	500mm	560mm
	<b>B60 L or R T</b> •	600mm	560mm
 <ul style="list-style-type: none"> <li>2 Doors</li> <li>1 Adjustable shelf including drip tray</li> </ul>	<b>B90 T</b>	900mm	560mm
	<b>B100 T</b> •	1000mm	560mm
<b>High Line Sink Base Unit</b>			
 <ul style="list-style-type: none"> <li>1 Door</li> <li>1 Adjustable shelf</li> <li>Removable back</li> </ul>	<b>BSK50 L or R</b> •	500mm	560mm
	<b>BSK60 L or R</b> •	600mm	560mm
 <ul style="list-style-type: none"> <li>2 Doors</li> <li>1 Adjustable shelf</li> <li>Removable back</li> </ul>	<b>BSK80</b>	800mm	560mm
	<b>BSK90</b>	900mm	560mm
	<b>BSK100</b> •	1000mm	560mm
	<b>BSK120</b> •	1200mm	560mm
<b>High Line Sink Base Unit with Drip Tray</b>			
 <ul style="list-style-type: none"> <li>1 Door</li> <li>1 Adjustable shelf including drip tray</li> <li>Removable back</li> </ul>	<b>BSK50 L or R T</b> •	500mm	560mm
	<b>BSK60 L or R T</b> •	600mm	560mm
 <ul style="list-style-type: none"> <li>2 Doors</li> <li>1 Adjustable shelf including drip tray</li> <li>Removable back</li> </ul>	<b>BSK80T</b>	800mm	560mm
	<b>BSK90 T</b>	900mm	560mm
	<b>BSK100 T</b> •	1000mm	560mm

# HIGH LINE BASE UNITS

## HIGH LINE BASE UNITS

Model/Description

Product Code

Width

Depth Excluding Door

### High Line Base Unit with Rectangular Waste Bin

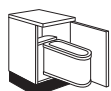

1 Door  
1 Rectangular waste bin  
Removable back

BSK50 L or R A5

•

500mm

560mm

BSK60 L or R A5

•

600mm

560mm

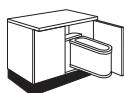

2 Doors  
1 Rectangular waste bin  
Removable back  
† L or R = handing of bin

BSK90 L† or R† A5

900mm

560mm

BSK100 L† or R† A5

•

1000mm

560mm

BSK120 L† or R† A5

•

1200mm

560mm

### High Line Sink Base Unit with Rectangular Waste Bin and Drip Tray

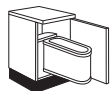

1 Door  
1 Rectangular waste bin  
Including drip tray  
Removable back

BSK50 L or R A5T

•

500mm

560mm

BSK60 L or R A5T

•

600mm

560mm

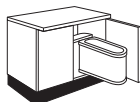

2 Doors  
1 Rectangular waste bin. Including drip tray  
Removable back  
† L or R = handing of bin

BSK90 L† or R† A5T

900mm

560mm

BSK100 L† or R† A5T

•

1000mm

560mm

### Corner Base Unit

Refer to planning notes for all corner options. HBO, UBO, OWN, MGB, ICS, IFS, SWS & CT range units are supplied with an adjustable corner post, requires cut and fitting. **W** = Door Size **L** = Left Hand Blank **R** = Right Hand Blank

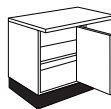

1 Door  
1 Adjustable shelf  
1 Blanking panel  
Including corner post  
Unit shown is Right Hand Blank

BC80 L or R 30 (-)

800/300mm(W)

560mm | 460mm(S)

BC80 L or R 40 (-)

800/400mm(W)

560mm | 460mm(S)

BC80 L or R 45 (-)

800/450mm(W)

560mm | 460mm(S)

BC80 L or R 50 (-)

•

800/500mm(W)

560mm | 460mm(S)

BC90 L or R 30 (-)

900/300mm(W)

560mm | 460mm(S)

BC90 L or R 40 (-)

900/400mm(W)

560mm | 460mm(S)

BC90 L or R 45 (-)

900/450mm(W)

560mm | 460mm(S)

BC90 L or R 50 (-)

•

900/500mm(W)

560mm | 460mm(S)

BC90 L or R 60 (-)

•

900/600mm(W)

560mm | 460mm(S)

BC100 L or R 40 (-)

1000/400mm(W)

560mm | 460mm(S)

BC100 L or R 45 (-)

1000/450mm(W)

560mm | 460mm(S)

BC100 L or R 50 (-)

•

1000/500mm(W)

560mm | 460mm(S)

BC100 L or R 60 (-)

•

1000/600mm(W)

560mm | 460mm(S)

BC120 L or R 60 (-)

•

1200/600mm(W)

560mm | 460mm(S)

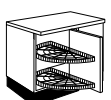

1 Door  
2 Semi-circular carousels  
1 Blanking panel  
Including corner post  
Unit shown is Right Hand Blank  
†† Includes silver solid carousels

BCC90 L or R 45††

900/450mm(W)

560mm

BCC100 L or R 45††

1000/450mm(W)

560mm

BCC100 L or R 50††

•

1000/500mm(W)

560mm

BCC120 L or R 60††

•

1200/600mm(W)

560mm

# HIGH LINE BASE UNITS

## HIGH LINE BASE UNITS

Model/Description	Product Code	Width	Depth Excluding Door
<b>Corner Base Unit with Vario Corner Pull-out Storage</b>			
Refer to planning notes for all corner options. HBO, UBO, OWN, MGB & CT range units are supplied with an adjustable corner post, requires cut and fitting. W = Door Size L = Left Hand Blank R = Right Hand Blank			

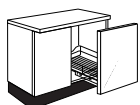

1 Door  
Pull-out storage systems with 4 baskets  
1 Blanking panel. Including corner post  
Unit shown is Left Hand Blank

BCV100 L or R 50



1000/500mm(W)

560mm

## Corner Base Unit with Le Mans Pull-out Storage

Refer to planning notes for all corner options. HBO, UBO, OWN, MGB & CT range units are supplied with an adjustable corner post, requires cut and fitting.  
W = Door Size L = Left Hand Blank R = Right Hand Blank



1 Door  
2 'Le Mans' carousels  
1 Blanking panel  
Including corner post  
Unit shown is Right Hand Blank

BCM100 L or R 50



1000/500mm(W)

560mm

## L - Shape Corner Base Unit

Supplied ready to assemble

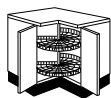

2 Doors  
170° Hinges  
2 Revolving carousels (360°)  
††Includes silver solid carousels



BCLC93††

930x930mm

560mm

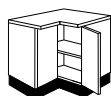

2 Doors  
170° Hinges  
1 Adjustable shelf

BCL93

930x930mm

560mm

BCL103

1030x1030mm

560mm

## L - Shape Revolving Corner Base Unit

Both Doors and Carousels revolve 360°. Supplied ready to assemble

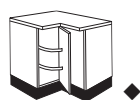

2 Doors  
2 Revolving carousels  
Including corner post  
Please note there is no void on this unit



BCLR93

930x930mm

560mm

## 45° Diagonal Corner Base Unit

Supplied ready to assemble



1 Door  
170° Hinges  
1 Adjustable shelf

BCD93 L or R

930x930mm

560mm

## L Shape Curved Corner Base Unit

Supplied ready to assemble



1 Door  
1 Adjustable shelf

BLCV93 L or R

930x930mm

560mm

## Curved End Base Unit

Note: Please refer to planning guidelines on page 198-199



1 Door  
1 Adjustable shelf

BPCE30 L or R

300mm

300mm

BE26 L or R

260mm

300mm

# DRAWER LINE BASE UNITS

## DRAWER LINE BASE UNITS

Model/Description

Product Code

Width

Depth Excluding Door

### Drawer Line Base Unit 720mm High

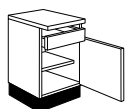

1 Door  
1 Drawer  
1 Adjustable shelf

BD30 L or R (-)

300mm

560mm | 460mm(S)

BD40 L or R (-)

400mm

560mm | 460mm(S)

BD45 L or R (-)

450mm

560mm | 460mm(S)

BD50 L or R (-)



500mm

560mm | 460mm(S)

BD60 L or R (-)



600mm

560mm | 460mm(S)

BD80 U (-)

800mm

560mm | 460mm(S)

BD90 U (-)

900mm

560mm | 460mm(S)

BD100 U (-)



1000mm

560mm | 460mm(S)

BD120 U (-)



1200mm

560mm | 460mm(S)

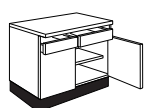

2 Doors  
2 Drawers  
1 Adjustable shelf

### Drawer Line Base Unit with Internal Tray Space

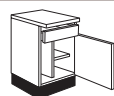

1 Door  
1 Drawer  
1 Adjustable shelf  
1 Tray space

BD45 L or R T1 (-)

450mm

560mm | 460mm(S)

BD50 L or R T1 (-)



500mm

560mm | 460mm(S)

BD60 L or R T1 (-)



600mm

560mm | 460mm(S)

### Drawer Line Base Unit with Internal Towel Rail

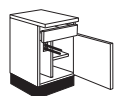

1 Door  
1 Drawer  
1 Adjustable shelf  
1 Towel rail  
1 Tray space

BD45 L or R T2

450mm

560mm

BD50 L or R T2



500mm

560mm

BD60 L or R T2



600mm

560mm

### Drawer Line Pull-out Base Unit 720mm High



1 Door  
1 Drawer  
1 Pull-out storage  
1 Internal drawer

BD30 P1

300mm

560mm

BD40 P1

400mm

560mm

BD45 P1

450mm

560mm

BD50 P1



500mm

560mm

BD60 P1



600mm

560mm

### Drawer Line Base Unit 720mm High with Dummy Drawer(s) and One Adjustable Shelf

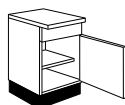

1 Door  
1 Dummy drawer  
1 Adjustable shelf

BDD30 L or R (-)

300mm

560mm | 460mm(S)

BDD40 L or R (-)

400mm

560mm | 460mm(S)

BDD45 L or R (-)

450mm

560mm | 460mm(S)

BDD50 L or R (-)



500mm

560mm | 460mm(S)

BDD60 L or R (-)



600mm

560mm | 460mm(S)

BDD80 U (-)

800mm

560mm | 460mm(S)

BDD90 U (-)

900mm

560mm | 460mm(S)

BDD100 U (-)



1000mm

560mm | 460mm(S)

BDD120 U (-)



1200mm

560mm | 460mm(S)

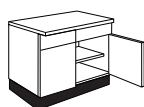

2 Doors  
2 Dummy drawers  
1 Adjustable shelf

### Drawer Line Sink Base Unit

Only available with metal drawers



2 Drawers  
1 Dummy drawer  
Cut-out for sink in the middle drawer

PDS90 D3









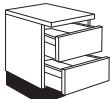

900mm

560mm

# DRAWER LINE BASE UNITS

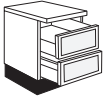
## DRAWER LINE BASE UNITS

Model/Description	Product Code	Width	Depth Excluding Door
<b>Drawer Unit</b>			
 ★ 4 Drawers (176 x 596)	<b>DPK60 D4 (-)</b>	600mm	560mm   460mm(S)
 ★ 5 Drawers	<b>DPK30 (-)</b>	300mm	560mm   460mm(S)
	<b>DPK40 (-)</b>	400mm	560mm   460mm(S)
	<b>DPK45 (-)</b>	450mm	560mm   460mm(S)
	<b>DPK50 (-)</b> ●	500mm	560mm   460mm(S)
	<b>DPK60 (-)</b> ●	600mm	560mm   460mm(S)
 ★ 2 Pan drawers †Sink drawer with cut-out (metal drawers only)	<b>PD60 D2 (-)</b>	600mm	560mm   460mm(S)
	<b>PD80 D2</b>	800mm	560mm   460mm(S)
	<b>PD100 D2 (-)</b>	1000mm	560mm   460mm(S)
	<b>PDS100 D2†</b>	1000mm	560mm
 ★ 1 Drawer 2 Pan drawers	<b>PD45 D3 (-)</b>	450mm	560mm   460mm(S)
	<b>PD50 D3 (-)</b>	500mm	560mm   460mm(S)
	<b>PD60 D3 (-)</b> ●	600mm	560mm   460mm(S)
	<b>PD80 D3 (-)</b>	800mm	560mm   460mm(S)
	<b>PD90 D3 (-)</b> ●	900mm	560mm   460mm(S)
 ★ 3 Drawers 1 Pan drawer	<b>PD45 D4 (-)</b>	450mm	560mm   460mm(S)
	<b>PD50 D4 (-)</b>	500mm	560mm   460mm(S)
	<b>PD60 D4 (-)</b> ●	600mm	560mm   460mm(S)
<b>Drawer Unit with Internal Top Drawer</b>			
 ★ 1 Internal drawer 2 Pan drawers	<b>PDT60 D2 (-)</b>	600mm	560mm   460mm(S)
	<b>PDT80 D2 (-)</b>	800mm	560mm   460mm(S)
	<b>PDT100 D2 (-)</b>	1000mm	560mm   460mm(S)
<b>Glass Front Drawer Unit</b> Only available with metal drawers			
 ★ 2 Pan drawers With aluminium framed glass fronts and handle suite 98 only	<b>PDG100 D2 (-)</b>	1000mm	560mm   460mm(S)
 ★ With aluminium framed glass fronts and handle suite 98 only	<b>PDG60 D3 A</b>	600mm	560mm
	<b>PDG90 D3 A</b>	900mm	560mm
 With range specific glass fronts with frosted glass	<b>PDG60 D3</b>	600mm	560mm
	<b>PDG90 D3</b>	900mm	560mm

# DRAWER LINE BASE UNITS

## DRAWER LINE BASE UNITS

Model/Description

Product Code

Width

Depth Excluding Door

### Drawer Line Base Breakfront Unit with 45° Front 720mm High

Right hand version illustrated

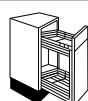

1 Door  
1 Dummy drawer front  
Pull-out storage on runners  
Unit breaks back 290mm

BDDBF30 L or R W1

300mm

560mm

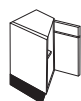

1 Door  
1 Dummy drawer front  
Unit breaks back 290mm

BDDBF30 L or R

300mm

560mm

### Drawer Line Base Unit with Pull-out Wirework 720mm High

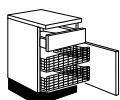

1 Door  
1 Drawer  
2 x 140mm High vegetable baskets

BD40 L or R W5

400mm

560mm

BD50 L or R W5



500mm

560mm

BD60 L or R W5



600mm

560mm

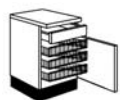

1 Door  
1 Drawer  
3 x 140mm High vegetable baskets

BD40 L or R W6

400mm

560mm

BD50 L or R W6



500mm

560mm

BD60 L or R W6



600mm

560mm

### Base Unit with Cylinder Waste Bin

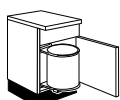

1 Door  
1 Drawer  
1 Cylinder waste bin  
(15L Capacity)

BD40 L or R A2

400mm

560mm

### Base Unit with Swing-out Combi Waste Bin

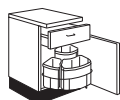

1 Door  
1 Drawer  
1 Swing out combi waste bin  
(Capacity 19L, 12L & 9L Total 40L)

BD50 L or R A7



500mm

560mm

### Base Unit with Rectangular Waste Bin

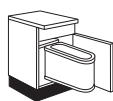

1 Door  
1 Drawer  
1 Rectangular waste bin  
(18L Capacity)

BD45 L or R A5

450mm

560mm

BD50 L or R A5



500mm

560mm

BD60 L or R A5



600mm

560mm

### Base Unit with Pull-out Waste Bin



1 Pull-out Door  
3 Loose Bins  
(Capacity 60L)

BD45 A9

450mm

560mm



BD50 A9

500mm

560mm

# DRAWER LINE BASE UNITS

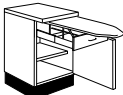
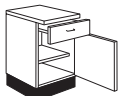
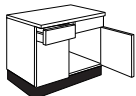
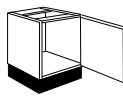
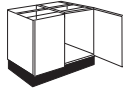
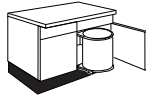
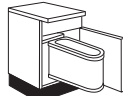
## DRAWER LINE BASE UNITS

Model/Description	Product Code	Width	Depth Excluding Door
<b>Base Unit with Pull-out Ironing Board</b>			
Foam lined cover			
 <ul style="list-style-type: none"> <li>1 Door</li> <li>1 Dummy drawer front</li> <li>1 Adjustable shelf</li> <li>1 Pull-out ironing board + sleeve arm</li> </ul>	<b>BDD50</b> L or R A3 •	500mm	560mm
<b>Base Unit with Pull-out Table</b>			
Load bearing capacity is 100kg. Maximum extension 800mm. Table in beige laminate			
 <ul style="list-style-type: none"> <li>1 Door</li> <li>1 Dummy drawer front</li> <li>1 Adjustable shelf</li> <li>1 Pull-out table</li> </ul>	<b>BDD60</b> L or R A4 •	600mm	560mm
<b>Sink Base Unit 720mm High with Working Drawer</b>			
 <ul style="list-style-type: none"> <li>2 Doors. 1 Drawer front - 1 dummy drawer front</li> <li>Without adjustable shelf</li> <li>State L/R dummy drawer front</li> <li>Unit shown is Right Hand dummy drawer</li> <li>†Including drip tray</li> </ul>	<b>BSK100</b> L or R D •	1000mm	560mm
	<b>BSK120</b> L or R D •	1200mm	560mm
	<b>BSK100</b> L or R D T† •	1000mm	560mm
<b>Belfast Sink Base Unit 460mm High</b>			
 <ul style="list-style-type: none"> <li>1 Door (450 x 596)</li> <li>See page 149 for 600mm Belfast Sink</li> </ul>	<b>BEL60</b> L or R	600mm	560mm
 <ul style="list-style-type: none"> <li>2 Doors (450 x 446)</li> <li>Without adjustable shelf</li> <li>See page 149 for 900mm Belfast Sink</li> </ul>	<b>BEL90</b>	900mm	560mm
<b>Sink Base Unit with Cylinder Waste Bin 720mm High</b>			
 <ul style="list-style-type: none"> <li>2 Doors</li> <li>2 Dummy drawer fronts</li> <li>Without adjustable shelf</li> <li>††State bin behind L/R door</li> <li>†Including drip tray</li> </ul>	<b>BDD100</b> L or R A1†† •	1000mm	560mm
	<b>BDD100</b> L or R A1†† T† •	1000mm	560mm
<b>Base Unit with Rectangular Waste Bin</b>			
With dummy drawer front			
 <ul style="list-style-type: none"> <li>1 Door</li> <li>1 Dummy drawer</li> <li>1 Rectangular waste bin</li> </ul>	<b>BDD45</b> L or R A5	450mm	560mm
	<b>BDD50</b> L or R A5 •	500mm	560mm
	<b>BDD60</b> L or R A5 •	600mm	560mm
<b>Base Unit with Rectangular Waste Bin and Drip Tray with Dummy Drawer Front</b>			
 <ul style="list-style-type: none"> <li>1 Door</li> <li>1 Dummy drawer</li> <li>1 Rectangular waste bin</li> <li>Including drip tray</li> </ul>	<b>BDD50</b> L or R A5T •	500mm	560mm
	<b>BDD60</b> L or R A5T •	600mm	560mm

# DRAWER LINE BASE UNITS

## DRAWER LINE BASE UNITS

Model/Description	Product Code	Width	Depth Excluding Door
-------------------	--------------	-------	----------------------

### Drawer Line Sink Base Unit with Dummy Drawer(s)

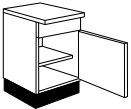
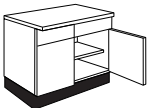
 <p>1 Door 1 Dummy drawer 1 Adjustable shelf Removable back</p>	<b>BDDSK50</b> L or R •	500mm	560mm
	<b>BDDSK60</b> L or R •	600mm	560mm
 <p>2 Doors 2 Dummy Drawers 1 Adjustable shelf Removable back</p>	<b>BDDSK80</b>	800mm	560mm
	<b>BDDSK90</b>	900mm	560mm
	<b>BDDSK100</b> •	1000mm	560mm
	<b>BDDSK120</b> •	1200mm	560mm

### Drawer Line Sink Base Unit with Dummy Drawer(s) with Drip Tray

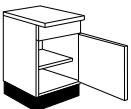
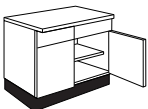
 <p>1 Door 1 Dummy drawer 1 Adjustable shelf Including drip tray Removable back</p>	<b>BDDSK50</b> L or R T •	500mm	560mm
	<b>BDDSK60</b> L or R T •	600mm	560mm
 <p>2 Doors 2 Dummy drawers 1 Adjustable shelf Including drip tray Removable back</p>	<b>BDDSK80</b> T	800mm	560mm
	<b>BDDSK90</b> T	900mm	560mm
	<b>BDDSK100</b> T •	1000mm	560mm

### Drawer Line Sink Base Unit with Dummy Drawer(s) with Rectangular Waste Bin

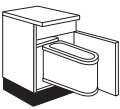
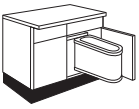
 <p>1 Door 1 Dummy drawer 1 Rectangular waste bin Removable back</p>	<b>BDDSK50</b> L or R A5 •	500mm	560mm
	<b>BDDSK60</b> L or R A5 •	600mm	560mm
 <p>2 Doors. 2 Dummy drawers 1 Rectangular waste bin Removable back † L or R= handing of bin</p>	<b>BDDSK90</b> L† or R† A5	900mm	560mm
	<b>BDDSK100</b> L† or R† A5 •	1000mm	560mm
	<b>BDDSK120</b> L† or R† A5 •	1200mm	560mm

### Drawer Line Sink Base Unit with Dummy Drawer(s) with Rectangular Waste Bin and Drip Tray

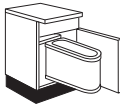
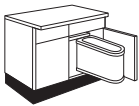
 <p>1 Door. 1 Dummy drawer 1 Rectangular waste bin Including drip tray Removable back</p>	<b>BDDSK50</b> L or R A5T •	500mm	560mm
	<b>BDDSK60</b> L or R A5T •	600mm	560mm
 <p>2 Doors. 2 Dummy drawers 1 Rectangular waste bin Including drip tray Removable back † L or R= handing of bin</p>	<b>BDDSK90</b> L† or R† A5T •	900mm	560mm
	<b>BDDSK100</b> L† or R† A5T •	1000mm	560mm

### Base Unit with Pull-out Wicker Basket

 <p>★ 1 Drawer 2 Pull-out wicker baskets on wooden runners</p>	<b>BDWK50</b>	500mm	560mm
---	---------------	-------	-------

# DRAWER LINE BASE UNITS

## DRAWER LINE BASE UNITS

Model/Description

Product Code

Width

Depth Excluding Door

### Corner Base Unit

Refer to planning notes for all corner options. HBO, UBO, OWN, MGB, ICS, IFS, SWS & CT range units are supplied with an adjustable corner post, requires cut and fitting. **W** = Door Size **L** = Left Hand Blank **R** = Right Hand Blank

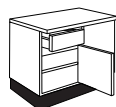



- 1 Door
- 1 Drawer
- 1 Adjustable shelf
- 1 Blanking panel
- Including corner post
- Unit shown is Right Hand Blank

<b>BDC80</b> L or R 30 (-)	800/300mm(W)	560mm   460mm(S)
<b>BDC80</b> L or R 40 (-)	800/400mm(W)	560mm   460mm(S)
<b>BDC80</b> L or R 45 (-)	800/450mm(W)	560mm   460mm(S)
<b>BDC80</b> L or R 50 (-) •	800/500mm(W)	560mm   460mm(S)
<b>BDC90</b> L or R 30 (-)	900/300mm(W)	560mm   460mm(S)
<b>BDC90</b> L or R 40 (-)	900/400mm(W)	560mm   460mm(S)
<b>BDC90</b> L or R 45 (-)	900/450mm(W)	560mm   460mm(S)
<b>BDC90</b> L or R 50 (-) •	900/500mm(W)	560mm   460mm(S)
<b>BDC90</b> L or R 60 (-) •	900/600mm(W)	560mm   460mm(S)
<b>BDC100</b> L or R 40 (-)	1000/400mm(W)	560mm   460mm(S)
<b>BDC100</b> L or R 45 (-)	1000/450mm(W)	560mm   460mm(S)
<b>BDC100</b> L or R 50 (-) •	1000/500mm(W)	560mm   460mm(S)
<b>BDC100</b> L or R 60 (-) •	1000/600mm(W)	560mm   460mm(S)
<b>BDC120</b> L or R 60 (-) •	1200/600mm(W)	560mm   460mm(S)

### Corner Base Unit with Carousels

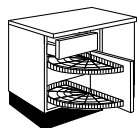
Refer to planning notes for all corner options. HBO, UBO, OWN, MGB, ICS, IFS, SWS & CT range units are supplied with an adjustable corner post, requires cut and fitting. **W** = Door Size **L** = Left Hand Blank **R** = Right Hand Blank



- 1 Door
- 1 Drawer
- 2 Semi-circular carousels
- 1 Blanking panel
- Including corner post
- Unit shown is Right Hand Blank
- †Includes silver solid carousels 

<b>BDCC90</b> L or R 45†	900/450mm(W)	560mm
<b>BDCC100</b> L or R 45†	1000/450mm(W)	560mm
<b>BDCC100</b> L or R 50† •	1000/500mm(W)	560mm
<b>BDCC120</b> L or R 60† •	1200/600mm(W)	560mm

### Corner Base Unit with Vario Corner Pull-out Storage

Refer to planning notes for all corner options. HBO, UBO, OWN, MGB, ICS, IFS, SWS & CT range units are supplied with an adjustable corner post, requires cut and fitting. **W** = Door Size **L** = Left Hand Blank **R** = Right Hand Blank

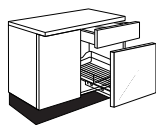

- 1 Door – 1 Drawer
- Pull-out storage system with 4 baskets
- 1 Blanking panel
- Including corner post
- Unit shown is Left Hand Blank

<b>BDCV100</b> L or R 50 •	1000/500mm(W)	560mm
----------------------------	---------------	-------

### Corner Base Unit with Le Mans Pull-out Storage

Refer to planning notes for all corner options. HBO, UBO, OWN, MGB, ICS, IFS, SWS & CT range units are supplied with an adjustable corner post, requires cut and fitting. **W** = Door Size **L** = Left Hand Blank **R** = Right Hand Blank

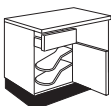

- 1 Door
- 1 Drawer
- 2 Le Mans carousels
- 1 Blanking panel
- Including corner post
- Unit shown is RH blank

<b>BDCM100</b> L or R 50 •	1000/500mm(W)	560mm
----------------------------	---------------	-------

### Sink Corner Base Unit

Refer to planning notes for all corner options. HBO, UBO, OWN, MGB, ICS, IFS, SWS & CT range units are supplied with an adjustable corner post, requires cut and fitting. **W** = Door Size **L** = Left Hand Blank **R** = Right Hand Blank

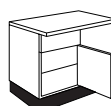

- 1 Door
- 1 Dummy drawer
- 1 Blanking panel
- Including corner post
- Without adjustable shelf
- Unit shown is Right Hand Blank

<b>BSKC100</b> L or R D50 •	1000/500mm(W)	560mm
<b>BSKC100</b> L or R D60 •	1000/600mm(W)	560mm
<b>BSKC120</b> L or R D60 •	1200/600mm(W)	560mm

# DRAWER LINE BASE UNITS

## DRAWER LINE BASE UNITS

Model/Description

Product Code

Width

Depth Excluding Door

### L - Shape Corner Base Unit

Supplied in full ready to assemble

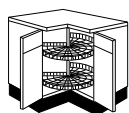

2 Doors  
170° Hinges  
2 Dummy drawer fronts  
2 Revolving carousels (360°)  
†Includes silver solid carousels 

BDCLC93†

930 x 930mm

560mm

### L - Shape Corner Base Unit

Supplied in full ready to assemble

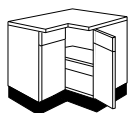

2 Doors  
170° Hinges  
2 Dummy drawer fronts  
1 Adjustable shelf

BDCL93

930 x 930mm

560mm

BDCL103

1030 x 1030mm

560mm

### L - Shape Revolving Corner Base Unit

Both Doors and Carousels revolve 360°  
Supplied in full ready to assemble

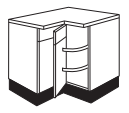

2 Doors  
2 Dummy drawer fronts  
2 Revolving carousels  
Including corner post  
Please note there is no void on this unit

BDCLR93

930 x 930mm

560mm

### 45° Diagonal Corner Base Unit

Supplied in full ready to assemble

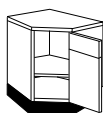

1 Door  
170° Hinges  
1 Dummy drawer front  
1 Adjustable shelf

BDCD93 L or R

930 x 930mm

560mm

### Low Base Unit - 576mm High

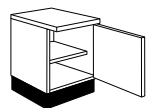

1 Door  
1 Adjustable shelf

BL50 L or R

•

500mm

560mm

BL60 L or R

•

600mm

560mm

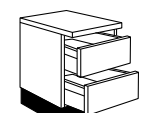

2 Pan drawers

PDL60 D2

•

600mm

560mm

PDL90 D2







•

900mm

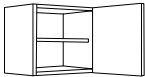
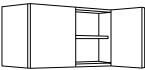
560mm

## LOW WALL UNITS

## LOW WALL UNITS – 576MM HIGH

Model/Description	Product Code	Width	Depth Excluding Door
<b>Standard Wall Unit</b>			
 <p>1 Door 1 Adjustable shelf</p>	WL30 L or R (-)	300mm	300mm   350mm(D)
	WL40 L or R (-)	400mm	300mm   350mm(D)
	WL45 L or R (-)	450mm	300mm   350mm(D)
	WL50 L or R (-) •	500mm	300mm   350mm(D)
	WL60 L or R (-) •	600mm	300mm   350mm(D)
 <p>2 Doors 1 Central divider 2 Adjustable shelves, 1 each side</p>	WL80 (-)	800mm	300mm   350mm(D)
	WL90 (-)	900mm	300mm   350mm(D)
	WL100 (-) •	1000mm	300mm   350mm(D)
	WL120 (-) •	1200mm	300mm   350mm(D)
<b>Breakfront/End Wall Unit</b>			
†Carcase depth 300mm + 50mm spacer panel. For planning details refer to page 157			
 <p>1 Door 1 Fixed shelf</p>	WLBFB30 L or R (-)	300mm	300mm   350mm(D)†
<b>Glass Wall Unit and Glass Wall Unit with Two Halogen Downlights</b>			
With aluminium framed screen printed glass doors – supplied with handle Suite 61 only			
 <p>1 Glass door 1 Glass adjustable shelf CH = Chrome Downlights</p>	WLGL50A L or R (-)	500mm	300mm   350mm(D)
	WLGL50A L or R CH (-)	500mm	300mm   350mm(D)
<b>Glass Wall Unit and Glass Wall Unit with Two Halogen Downlights</b>			
With range specific glass doors, with glazing bars and clear glass			
 <p>1 Glass door 1 Glass adjustable shelf CH = Chrome Downlights</p>	WLGL50G L or R (-)	500mm	300mm   350mm(D)
	WLGL50G L or R CH (-)	500mm	300mm   350mm(D)
<b>L – Shape Corner Wall Unit</b>			
 <p>2 Doors 170° Hinges 1 Adjustable shelf</p>	WLCL63	630 x 630mm	300mm
	WLCL68 D	680 x 680mm	350mm
<b>45° Corner Wall Unit</b>			
 <p>1 Door 1 Adjustable shelf</p>	WLCD63 L or R	630 x 630mm	300mm
<b>Conventional Corner Wall Unit</b>			
For planning details of all corner options refer to page 150-152 W = Door Size L = Left Hand Blank R = Right Hand Blank			
 <p>1 Door 1 Adjustable shelf 1 Blanking panel Unit shown is Left Hand Blank</p>	WLC60 L or R 30 (-)	600/300mm(W)	300mm   350mm(D)
	WLC60 L or R 40 (-)	600/400mm(W)	300mm   350mm(D)

## LOW WALL UNITS

## WALL BRIDGING UNITS (FOR USE WITH 576MM HIGH UNITS)

Model/Description	Product Code	Width	Depth Excluding Door
-------------------	--------------	-------	----------------------

## Wall Telescopic Extractor Unit – 288mm High

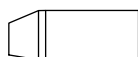

1 Fixed door

WLTP60 (-)

600mm

300mm | 350mm(D)

## WALL DRESSER UNITS (FOR USE WITH 576MM HIGH UNITS)

## Glass Dresser Unit and Glass Dresser Unit with Two Halogen Downlights – 1063mm High

With aluminium framed screen printed glass doors

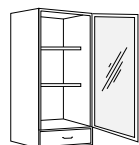

1 Glass door  
2 Glass adjustable shelves  
1 Drawer  
CH=Chrome Downlights

DLGL50A L or R (-)

500mm

300mm | 350mm(D)

DLGL50A L or R CH (-)

500mm

300mm | 350mm(D)

## Glass Dresser Unit and Glass Dresser Unit with Two Halogen Downlights – 1063mm High

With range specific glass doors, with plain frames and frosted glass

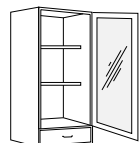

1 Glass door  
2 Glass adjustable shelves  
1 Drawer  
CH=Chrome Downlights

DLGL50F L or R (-)

500mm

300mm | 350mm(D)

DLGL50F L or R CH (-)

500mm

300mm | 350mm(D)

## Glass Dresser Unit and Glass Dresser Unit with Two Halogen Downlights – 1063mm High

With range specific glass doors, with plain frames and clear glass

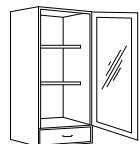

1 Glass door  
2 Glass adjustable shelves  
1 Drawer  
CH=Chrome Downlights

DLGL50C L or R (-)

500mm

300mm | 350mm(D)

DLGL50C L or R CH (-)

500mm

300mm | 350mm(D)

## Glass Dresser Unit and Glass Dresser Unit with Two Halogen Downlights – 1063mm High

With range specific glass doors, with glazing bars and clear glass

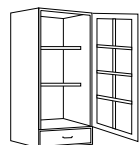

1 Glass door  
2 Glass adjustable shelves  
1 Drawer  
CH=Chrome Downlights

DLGL50G L or R (-)

500mm

300mm | 350mm(D)

DLGL50G L or R CH (-)

500mm

300mm | 350mm(D)

## Lattice Dresser Unit – 1063mm High

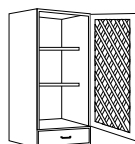

1 Lattice door  
2 Adjustable glass shelves  
1 Drawer





DLLA50 L or R (-)

500mm

300mm | 350mm(D)

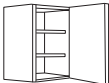
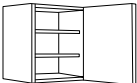
## MEDIUM WALL UNITS

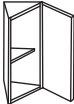
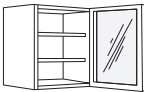
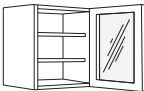
## MEDIUM WALL UNITS - 720MM HIGH

Model/Description	Product Code	Width	Depth Excluding Door
<b>Standard Wall Unit</b>			
 1 Door 2 Adjustable shelves	<b>WM15</b> L or R (-) •	150mm	300mm   350mm(D)
 1 Door 2 Adjustable shelves	<b>WM30</b> L or R (-)	300mm	300mm   350mm(D)
	<b>WM40</b> L or R (-)	400mm	300mm   350mm(D)
	<b>WM45</b> L or R (-)	450mm	300mm   350mm(D)
	<b>WM50</b> L or R (-) •	500mm	300mm   350mm(D)
	<b>WM60</b> L or R (-) •	600mm	300mm   350mm(D)
 2 Doors 1 Central divider 4 Adjustable shelves, 2 each side	<b>WM80</b> U (-)	800mm	300mm   350mm(D)
	<b>WM90</b> U (-)	900mm	300mm   350mm(D)
	<b>WM100</b> U (-) •	1000mm	300mm   350mm(D)
	<b>WM120</b> U (-) •	1200mm	300mm   350mm(D)
<b>Breakfront/End Wall Unit</b>			
*Carcase depth 300mm + 50mm spacer panel. For planning details refer to page 157			
 1 Door 1 Fixed shelf	<b>WMBF30</b> L or R (-)	300mm	300mm   350mm(D)
<b>Glass Wall Unit and Glass Wall Unit with Two Halogen Downlights</b>			
With aluminium framed screen printed glass doors			
 1 Glass door 2 Glass adjustable shelves CH = Chrome Downlights	<b>WMGL40A</b> L or R (-)	400mm	300mm   350mm(D)
	<b>WMGL40A</b> L or R CH (-)	400mm	300mm   350mm(D)
	<b>WMGL50A</b> L or R (-)	500mm	300mm   350mm(D)
	<b>WMGL50A</b> L or R CH (-)	500mm	300mm   350mm(D)
<b>Glass Wall Unit and Glass Wall Unit with Two Halogen Downlights</b>			
With range specific glass doors, with plain frames and frosted glass			
 1 Glass door 2 Glass adjustable shelves CH = Chrome Downlights	<b>WMGL40F</b> L or R (-)	400mm	300mm   350mm(D)
	<b>WMGL40F</b> L or R CH (-)	400mm	300mm   350mm(D)
	<b>WMGL50F</b> L or R (-)	500mm	300mm   350mm(D)
	<b>WMGL50F</b> L or R CH (-)	500mm	300mm   350mm(D)
<b>Glass Wall Unit and Glass Wall Unit with Two Halogen Downlights</b>			
With range specific glass doors, with plain frames and clear glass			
 1 Glass door 2 Glass adjustable shelves CH = Chrome Downlights	<b>WMGL40C</b> L or R (-)	400mm	300mm   350mm(D)
	<b>WMGL40C</b> L or R CH (-)	400mm	300mm   350mm(D)
	<b>WMGL50C</b> L or R (-)	500mm	300mm   350mm(D)
	<b>WMGL50C</b> L or R CH (-)	500mm	300mm   350mm(D)
<b>Glass Wall Unit and Glass Wall Unit with Two Halogen Downlights</b>			
With range specific glass doors, with glazing bars and clear glass			
 1 Glass door 2 Glass adjustable shelves CH = Chrome Downlight	<b>WMGL40G</b> L or R (-)	400mm	300mm   350mm(D)
	<b>WMGL40G</b> L or R CH (-)	400mm	300mm   350mm(D)
	<b>WMGL50G</b> L or R (-)	500mm	300mm   350mm(D)
	<b>WMGL50G</b> L or R CH (-)	500mm	300mm   350mm(D)

## MEDIUM WALL UNITS

## MEDIUM WALL UNITS - 720MM HIGH

Model/Description

Product Code

Width

Depth Excluding Door

## L - Shape Corner Wall Unit



2 Doors  
170° hinges  
2 Adjustable shelves

WMCL63

630 x 630mm

300mm

WMCL68 D

680 x 680mm

350mm

## 45° Corner Wall Unit

A 630mm deep open corner wall unit is also available. See page 67



1 Door  
2 Adjustable shelves

WMCD63 L or R

630 x 630mm

300mm

WMCD68 L or R D

680 x 680mm

350mm

## 45° Glass Corner Wall Unit

With aluminium framed screen printed glass doors



1 Glass door  
2 MFC adjustable shelves

WMCDGL63A L or R

630 x 630mm

300mm

WMCDGL68A L or R D

680 x 680mm

350mm

## 45° Glass Corner Wall Unit

With range specific glass doors, with plain frames and frosted glass



1 Glass door  
2 MFC adjustable shelves

WMCDGL63F L or R

630 x 630mm

300mm

WMCDGL68F L or R D

680 x 680mm

350mm

## 45° Glass Corner Wall Unit

With range specific glass doors, with plain frames and clear glass



1 Glass door  
2 MFC adjustable shelves

WMCDGL63C L or R

630 x 630mm

300mm

WMCDGL68C L or R D

680 x 680mm

350mm

## 45° Glass Corner Wall Unit

With range specific glass doors, with glazing bars and clear glass



1 Glass door  
2 MFC adjustable shelves

WMCDGL63G L or R

630 x 630mm

300mm

WMCDGL68G L or R D

680 x 680mm

350mm

## Conventional Corner Wall Unit

For planning details of all corner options refer to page 150-152

W = Door Size L = Left Hand Blank R = Right Hand Blank



1 Door  
2 Adjustable shelves  
1 Blanking panel  
Unit shown is Left Hand Blank

WMC60 L or R 30 (-)

600x300mm(W)

300mm | 350mm(D)

WMC60 L or R 40 (-)

600x400mm(W)

300mm | 350mm(D)

WMC60 L or R 45 (-)

600x450mm(W)

300mm | 350mm(D)

WMC80 L or R 50 (-) •

800x500mm(W)

300mm | 350mm(D)

WMC90 L or R 60 (-) •

900x600mm(W)

300mm | 350mm(D)

## Curved L Shape Corner Wall Unit



1 Door  
2 Adjustable shelves

WMCLCV67 L or R

670 x 670mm

300mm

## MEDIUM WALL UNITS

## WALL BRIDGING UNITS (FOR USE WITH 720MM HIGH UNITS)

Model/Description	Product Code	Width	Depth Excluding Door
-------------------	--------------	-------	----------------------

## Wall Telescopic Extractor Unit – 343mm High



1 Lift up flap

WMTP60 (-)

600mm

300mm | 350mm(D)

## Curved End Wall Unit

Please see page 162-163 for planning guide

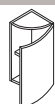
1 Door  
1 Fixed shelf

WMCE30 L or R

300mm

300mm

## Bridging Unit – 288mm High

1 Lift up flap  
\*Sheraton 'Contact' - please add £40 per unit

WMBG45 (-)

450mm

300mm | 350mm(D)

WMBG50 (-)

500mm

300mm | 350mm(D)

WMBG60 (-) •

600mm

300mm | 350mm(D)

WMBG80 (-)

800mm

300mm | 350mm(D)

WMBG90 (-) •

900mm

300mm | 350mm(D)

2 Lift up flaps  
\*Sheraton 'Contact' - please add £80 per unit

WMBG90D2 (-)

900mm

300mm | 350mm(D)

## Glass Bridging Unit – 288mm High

With aluminium framed glass flap with screen printed glass

1 Lift up aluminium framed glass flap  
and handle suite 98 only  
\*Not available in Sheraton 'Contact'

WMBGG60A (-)

600mm

300mm | 350mm(D)

WMBGG90A (-)

900mm

300mm | 350mm(D)

## Glass Bridging Unit – 288mm High

With range specific glass flap with frosted glass

1 Lift up glass flap  
\*Sheraton 'Contact' - please add £40 per unit

WMBGG60F (-)

600mm

300mm | 350mm(D)

WMBGG90F (-)

900mm

300mm | 350mm(D)

## Single Bridging Unit – 360mm High

1 Lift up glass flap  
\*Sheraton 'Contact' - please add £40 per unit

WMBG100 (-)

1000mm

300mm | 350mm

## Double Flap Bridging Unit – 576mm High

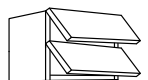
2 Lift up glass flap  
\*Sheraton 'Contact' - please add £80 per unit

WMDBG50 (-)

500mm

300mm | 350mm(D)

WMDBG60 (-) •

600mm

300mm | 350mm(D)

WMDBG80 (-)

800mm

300mm | 350mm(D)

WMDBG90 (-) •

900mm

300mm | 350mm(D)

## Double Flap Bridging Unit – 576mm High

With two aluminium framed glass flaps with screen printed glass

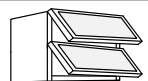
2 Lift up aluminium framed glass flaps  
and handle suite 98 only  
\*Not available in Sheraton 'Contact'

WMBGG60A (-)

600mm

300mm | 350mm(D)

WMBGG90A (-)

900mm

300mm | 350mm(D)

## MEDIUM WALL UNITS

## WALL BRIDGING UNITS (FOR USE WITH 720MM HIGH UNITS)

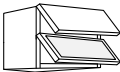
Model/Description	Product Code	Width	Depth Excluding Door	
<b>Double Flap Bridging Unit – 576mm High</b> With aluminium framed glass lower flap with screen printed glass				
	1 Lift up flap. 1 Lift up aluminium framed glass lower flap with handle suite 98 only on the glass flap *Not available in Sheraton 'Contact'	WMDBGSG60A (-) •	600mm	300mm   350mm(D)
		WMDBGSG90A (-) •	900mm	300mm   350mm(D)

**Double Flap Bridging Unit – 576mm High**

With two range specific glass flaps with frosted glass

	2 Lift up glass flaps *Sheraton 'Contact' - please add £80 per unit	WMDBGG60F (-)	600mm	300mm   350mm(D)
		WMDBGG90F (-)	900mm	300mm   350mm(D)

**Double Flap Bridging Unit – 576mm High**

With range specific glass lower flap with frosted glass

	1 Lift up flap 1 Lift up glass flap *Sheraton 'Contact' - please add £80 per unit	WMDBGSG60F (-)	600mm	300mm   350mm(D)
		WMDBGSG90F (-)	900mm	300mm   350mm(D)

**Bi-Fold Bridging Unit – 720mm High**

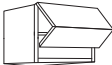
	2 Bi-Fold flaps	WMDBG60T1 (-)	600mm	300mm   350mm(D)
		WMDBG80T1 (-)	800mm	300mm   350mm(D)
		WMDBG100T1	1000mm	300mm   350mm(D)

**Bi-Fold Bridging Unit – One Glass Door – 720mm High**

	2 Bi-Fold flaps Lower flap with aluminium framed glass with handle suite 98 only on glass flap	WMDBGSG100A (-)	1000mm	300mm   350mm(D)
---	---	-----------------	--------	------------------

## WALL DRESSER UNITS (FOR USE WITH 720MM HIGH UNITS)

**Glass Dresser Unit and Glass Dresser Unit with Two Halogen Downlights – 1207mm High**

With aluminium framed screen printed glass doors

	1 Glass door 3 Glass adjustable shelves. 1 Drawer CH = Chrome Downlights Dressers not available in 'Sheraton contact'	DMGL50A L or R (-)	500mm	300mm   350mm(D)
		DMGL50A L or R CH (-)	500mm	300mm   350mm(D)

**Glass Dresser Unit and Glass Dresser Unit with Two Halogen Downlights – 1207mm High**

With range specific glass doors, with plain frames and frosted glass

	1 Glass door 3 Glass adjustable shelves. 1 Drawer CH = Chrome Downlights Dressers not available in 'Sheraton contact'	DMGL50F L or R (-)	500mm	300mm   350mm(D)
		DMGL50F L or R CH (-)	500mm	300mm   350mm(D)

**Glass Dresser Unit and Glass Dresser Unit with Two Halogen Downlights – 1207mm High**

With range specific glass doors, with plain frames and clear glass

	1 Glass door 3 Glass adjustable shelves. 1 Drawer CH = Chrome Downlights Dressers not available in 'Sheraton contact'	DMGL50C L or R (-)	500mm	300mm   350mm(D)
		DMGL50C L or R CH (-)	500mm	300mm   350mm(D)

**Glass Dresser Unit and Glass Dresser Unit with Two Halogen Downlights – 1207mm High**

With range specific glass doors, with glazing bars and clear glass





	1 Glass door 3 Glass adjustable shelves. 1 Drawer CH = Chrome Downlights Dressers not available in 'Sheraton contact'	DMGL50G L or R (-)	500mm	300mm   350mm(D)
		DMGL50G L or R CH (-)	500mm	300mm   350mm(D)

**Lattice Dresser Unit – 1207mm High**

	1 Lattice door 3 Adjustable glass shelves 1 Drawer Dressers not available in 'Sheraton contact'	DMLA50 L or R (-)	500mm	300mm   350mm(D)
---	--	-------------------	-------	------------------

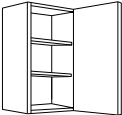
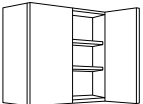
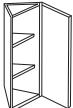
## TALL WALL UNITS

## TALL WALL UNITS – 900MM HIGH

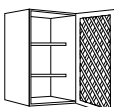
Model/Description	Product Code	Width	Depth Excluding Door
<b>Standard Wall Unit</b>			
 <p>1 Door 2 Adjustable shelves</p>	WT30 L or R (-)	300mm	300mm   350mm(D)
	WT40 L or R (-)	400mm	300mm   350mm(D)
	WT45 L or R (-)	450mm	300mm   350mm(D)
	WT50 L or R (-)	500mm	300mm   350mm(D)
	WT60 L or R (-)	600mm	300mm   350mm(D)
 <p>2 Doors 1 Central divider 4 Adjustable shelves, 2 each side</p>	WT80 (-)	800mm	300mm   350mm(D)
	WT90 (-)	900mm	300mm   350mm(D)
	WT100 (-)	1000mm	300mm   350mm(D)
	WT120 (-)	1200mm	300mm   350mm(D)
<b>Breakfront/End Wall Unit</b>			
*Carcase depth 300mm + 50mm spacer panel. For planning details refer to page 157			
 <p>1 Door 2 Fixed shelves</p>	WTBF30 L or R (-)	300mm	300mm   350mm(D)*
<b>Glass Wall Unit and Glass Wall Unit with Two Halogen Downlights</b>			
With aluminium framed screen printed glass doors			
 <p>1 Glass door 2 Glass adjustable shelves CH = Chrome Downlights</p>	WTGL50A L or R (-)	500mm	300mm   350mm(D)
	WTGL50A L or R CH (-)	500mm	300mm   350mm(D)
<b>Glass Wall Unit and Glass Wall Unit with Two Halogen Downlights</b>			
With range specific glass doors, with plain frames and frosted glass			
 <p>1 Glass door 2 Glass adjustable shelves CH = Chrome Downlights</p>	WTGL50F L or R (-)	500mm	300mm   350mm(D)
	WTGL50F L or R CH (-)	500mm	300mm   350mm(D)
<b>Glass Wall Unit and Glass Wall Unit with Two Halogen Downlights</b>			
With range specific glass doors, with plain frames and clear glass			
 <p>1 Glass door 2 Glass adjustable shelves CH = Chrome Downlights</p>	WTGL50C L or R (-)	500mm	300mm   350mm(D)
	WTGL50C L or R CH (-)	500mm	300mm   350mm(D)
<b>Glass Wall Unit and Glass Wall Unit with Two Halogen Downlights</b>			
With range specific glass doors, with glazing bars and clear glass			
 <p>1 Glass door 2 Glass adjustable shelves CH = Chrome Downlights</p>	WTGL50G L or R (-)	500mm	300mm   350mm(D)
	WTGL50G L or R CH (-)	500mm	300mm   350mm(D)
<b>Lattice Wall Unit</b>			
 <p>1 Lattice door 2 Adjustable glass shelves</p>	WTLA50 L or R (-)	500mm	300mm   350mm(D)

## TALL WALL UNITS

## TALL WALL UNITS – 900MM HIGH

Model/Description

Product Code

Width

Depth Excluding Door

## L – Shape Corner Wall Unit

A 630mm deep open corner wall unit is also available. See page 73

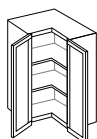

2 Doors (170° hinges)  
170° hinges  
2 Adjustable shelves

WTCL63

630 x 630mm

300mm

WTCL68 D

680 x 680mm

350mm

## 45° Corner Wall Unit

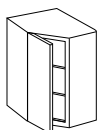

1 Door  
2 Adjustable shelves

WTCD63 L or R

630 x 630mm

300mm

WTCD68 L or R D

680 x 680mm

350mm

## Conventional Corner Wall Unit

For planning details of all corner options refer to page 150-152  
W = Door Size L = Left Hand Blank R = Right Hand Blank

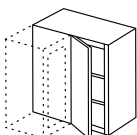

1 Door  
1 Adjustable shelf  
1 Blanking panel  
Unit shown is Left Hand Blank

WTC60 L or R 30 (—)

600 x 300mm(W)

300mm | 350mm(D)

WTC60 L or R 40 (—)

600 x 400mm(W)

300mm | 350mm(D)

WTC60 L or R 45 (—)

600 x 450mm(W)

300mm | 350mm(D)

WTC80 L or R 50 (—)

800 x 500mm(W)

300mm | 350mm(D)

WTC90 L or R 60 (—)

900 x 600mm(W)

300mm | 350mm(D)

## WALL BRIDGING UNITS (FOR USE WITH 900MM HIGH UNITS)

## Wall Telescopic Extractor Unit – 575mm High

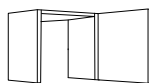

1 Door

WTTP60 L or R (—)

600mm

300mm | 350mm(D)

## Bridging Unit – 454mm High

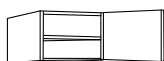

1 Door  
2 Adjustable shelves

WTBG45 L or R (—)

450mm

300mm | 350mm(D)

WTBG60 L or R (—)

600mm

300mm | 350mm(D)



2 Doors  
2 Adjustable shelves (1 each side)  
1 Central divider

WTBG90 (—)

900mm

300mm | 350mm(D)

## TALL WALL UNITS

## WALL DRESSER UNITS (FOR USE WITH 900MM HIGH UNITS)

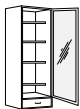
Model/Description	Product Code	Width	Depth Excluding Door
<b>Glass Dresser Unit and Glass Dresser Unit with Two Halogen Downlights - 1387mm High</b> With aluminium framed screen printed glass doors			
 <p>1 Glass door 4 Glass adjustable shelves 1 Drawer CH = Chrome Downlights</p> <p>Dressers not available in 'Sheraton Contact'</p>	DTGL50A L or R (-)	500mm	300mm   350mm(D)
	DTGL50A L or R CH (-)	500mm	300mm   350mm(D)

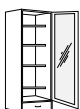
<b>Glass Dresser Unit and Glass Dresser Unit with Two Halogen Downlights - 1387mm High</b> With range specific glass doors, with plain frames and frosted glass			
 <p>1 Glass door 4 Glass adjustable shelves 1 Drawer CH = Chrome Downlights</p> <p>Dressers not available in 'Sheraton Contact'</p>	DTGL50F L or R (-)	500mm	300mm   350mm(D)
	DTGL50F L or R CH (-)	500mm	300mm   350mm(D)

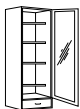
<b>Glass Dresser Unit and Glass Dresser Unit with Two Halogen Downlights - 1387mm High</b> With range specific glass doors, with plain frames and clear glass			
 <p>1 Glass door 4 Glass adjustable shelves 1 Drawer CH = Chrome Downlights</p> <p>Dressers not available in 'Sheraton Contact'</p>	DTGL50C L or R (-)	500mm	300mm   350mm(D)
	DTGL50C L or R CH (-)	500mm	300mm   350mm(D)

<b>Glass Dresser Unit and Glass Dresser Unit with Two Halogen Downlights - 1387mm High</b> With range specific glass doors, with glazing bars and clear glass			
 <p>1 Glass door 4 Glass adjustable shelves 1 Drawer CH = Chrome Downlights</p> <p>Dressers not available in 'Sheraton Contact'</p>	DTGL50G L or R (-)	500mm	300mm   350mm(D)
	DTGL50G L or R CH (-)	500mm	300mm   350mm(D)

## Lattice Dresser Unit - 1387mm High

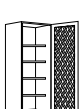

 <p>1 Lattice door 4 Adjustable glass shelves 1 Drawer</p> <p>Dressers not available in 'Sheraton Contact'</p>	DTLA50 L or R (-)	500mm	300mm   350mm(D)
---	-------------------	-------	------------------

SECTION  
3

# LARDER & PANTRY UNITS

.....SECTION 3 - LARDER & PANTRY UNITS

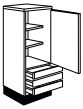
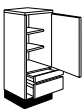
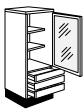
## EURO PANTRY UNITS - 1492MM HIGH (SIZE INC. 150MM LEG HEIGHT)

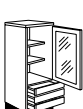
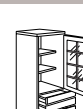
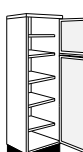
Model/Description		Product Code	Width	Depth Excluding Door
<b>Pantry Unit</b>				
	<p>Type 20 Pantry Unit            1 Door (H 896mm)            3 Drawers (H 140mm)            2 Adjustable shelves            1 Fixed shelf</p> <p>★</p>	Euro - 1492mm high <b>LUE50</b> L or R	500mm	560mm
	<p>Type 21 Pantry Unit            1 Door (H 896mm)            1 Drawer (H 140mm)            1 Pan drawer (H 284mm)            2 Adjustable shelves            1 Fixed shelf</p> <p>★</p>	Euro - 1492mm high <b>LUE60</b> L or R	600mm	560mm
<b>Pantry Unit with Aluminium Framed Screen Printed Glass Doors</b> Glass frame supplied with Suite 61				
	<p>Type 22 Pantry Unit            1 Glass door (H 896mm)            3 Drawers (H 140mm)            2 MFC Adjustable shelves            1 Fixed shelf</p> <p>◆ ★</p>	Euro - 1492mm high <b>LUEGL50A</b> L or R	500mm	560mm
<b>Pantry Unit with Range Specific Glass Doors, Plain Frames and Frosted Glass</b>				
	<p>Type 22 Pantry Unit            1 Glass door (H 896mm)            3 Drawers (H 140mm)            2 MFC Adjustable shelves            1 Fixed shelf</p> <p>★</p>	Euro - 1492mm high <b>LUEGL50F</b> L or R	500mm	560mm
<b>Pantry Unit with Range Specific Glass Doors, Plain Frames and Clear Glass</b>				
	<p>Type 22 Pantry Unit            1 Glass door (H 896mm)            3 Drawers (H 140mm)            2 MFC Adjustable shelves            1 Fixed shelf</p> <p>★</p>	Euro - 1492mm high <b>LUEGL50C</b> L or R	500mm	560mm
<b>Pantry Unit with Range Specific Glass Doors, Glazing Bars and Clear Glass</b>				
	<p>Type 22 Pantry Unit            1 Glass door (H 896mm)            3 Drawers (H 140mm)            2 MFC Adjustable shelves            1 Fixed shelf</p> <p>★</p>	Euro - 1492mm high <b>LUEGL50G</b> L or R	500mm	560mm
<b>GLASS DISPLAY CABINETS</b>				
<b>Glass Display Cabinet</b> With aluminium framed screen printed glass doors				
	<p>2 Glass Doors            (1 x 1245mm High)            (1 x varies acc to unit ht)            4 Glass adjustable shelves            1 Glass fixed shelf</p>	<p>Medium - 2117mm            (size includes 150mm            leg height)</p>	<b>DCM50</b> L or R (-) 500mm	300mm   350mm(D) 538
		<p>Tall - 2297mm            (size includes 150mm            leg height)</p>	<b>DCT50</b> L or R (-) 500mm	300mm   350mm(D) 562

SECTION  
3

# LARDER & PANTRY UNITS

SECTION 3 - LARDER & PANTRY UNITS

## LARDER/PANTRY UNITS

Model/Description	Product Code	Width	Depth Excluding Door
-------------------	--------------	-------	----------------------

**Larder/Pantry Unit** Low Units for use with 576mm high Wall Units  
Medium Units for use with 720mm high Wall Units. Tall Units for use with 900mm high Wall Units

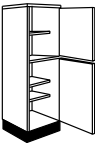
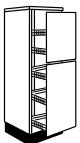
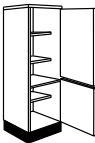
 <p>Type 1 Larder Unit/ Broom Unit 2 Doors (1 x varies acc to unit ht) (1 x 1245mm High) 3 Adjustable shelves 1 Movable fixed shelf</p>	Low - 1973mm high	LUL30 L or R T1 (-)	300mm	560mm   460mm(S)
		LUL50 L or R T1 (-)	500mm	560mm   460mm(S)
		LUL60 L or R T1 (-)	600mm	560mm   460mm(S)
	Medium - 2117mm high	LUM30 L or R T1 (-)	300mm	560mm   460mm(S)
		LUM50 L or R T1 (-)	500mm	560mm   460mm(S)
		LUM60 L or R T1 (-)	600mm	560mm   460mm(S)
	Tall - 2297mm high	LUT30 L or R T1 (-)	300mm	560mm   460mm(S)
		LUT50 L or R T1 (-)	500mm	560mm   460mm(S)
		LUT60 L or R T1 (-)	600mm	560mm   460mm(S)
 <p>Type 5 Larder Unit 2 Doors (1 x varies acc to unit ht) (1 x 1245mm High) Full height pull-out storage with 5 baskets</p>	Medium - 2117mm high	LUM30 T5	300mm	560mm
		LUM50 T5	500mm	560mm
	Tall - 2297mm high	LUT30 T5	300mm	560mm
		LUT50 T5	500mm	560mm
 <p>Type 6 Pantry Unit 2 Doors (1 x varies acc to unit ht) (1 x 1245mm High) 3 Adjustable shelves 1 Fixed shelf †Tall unit includes fixed drawer fascia</p>	Low - 1973mm high	LUL30 L or R T6	300mm	560mm
		LUL50 L or R T6	500mm	560mm
		LUL60 L or R T6	600mm	560mm
	Medium - 2117mm high	LUM30 L or R T6	300mm	560mm
		LUM50 L or R T6	500mm	560mm
		LUM60 L or R T6	600mm	560mm
	†Tall - 2297mm high	LUT60 L or R T6	600mm	560mm

**Larder/Pantry Unit** Low Units for use with 576mm high Wall Units  
Medium Units for use with 720mm high Wall Units. Tall Units for use with 900mm high Wall Units

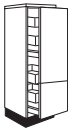
 <p>Type 11 Pantry Unit (1 x varies acc to unit ht) 2 Doors (1 x 1245mm High) 3 Pull-out storage 4 Internal drawers †Tall unit includes fixed drawer fascia</p>	Low - 1973mm high	LUL30 T11	300mm	560mm
		LUL50 T11	500mm	560mm
		LUL60 T11	600mm	560mm
	Medium - 2117mm high	LUM30 T11	300mm	560mm
		LUM50 T11	500mm	560mm
		LUM60 T11	600mm	560mm
	†Tall - 2297mm high	LUT60 T11	600mm	560mm

SECTION  
3

# LARDER & PANTRY UNITS

## LARDER/PANTRY UNITS

Model/Description	Product Code	Width	Depth Excluding Door
-------------------	--------------	-------	----------------------

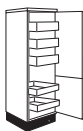
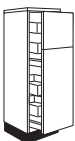
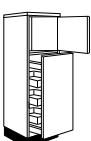
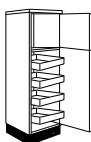

**Larder/Pantry Unit** Low Units for use with 576mm high Wall Units  
Medium Units for use with 720mm high Wall Units. Tall Units for use with 900mm high Wall Units

 <p>Type 12 Pantry Unit 2 Doors (1 x 1245mm High) (1 x varies acc to unit ht) 5 Drawers (Low) 6 Drawers (Med/Tall) † Tall Unit includes fixed drawer fascia</p>	Low - 1973mm high	LUL30 L or R (-) T12	300mm	560mm	
		LUL50 L or R (-) T12	500mm	560mm	
		LUL60 L or R (-) T12	600mm	560mm	
	Medium - 2117mm high	LUM30 L or R (-) T12	300mm	560mm	
		LUM50 L or R (-) T12	500mm	560mm	
		LUM60 L or R (-) T12	600mm	560mm	
	†Tall - 2297mm high	LUT60 L or R (-) T12	600mm	560mm	
	 <p>Type 13 Larder Unit 2 Doors (1 x varies acc to unit ht) (1 x 1245mm High) 3 Pull-out storage 4 Drawers (Low/Med) 5 Drawers (Tall)</p>	Low - 1973mm high	LUL30 T13	300mm	560mm
			LUL50 T13	500mm	560mm
LUL60 T13			600mm	560mm	
Medium - 2117mm high		LUM30 T13	300mm	560mm	
		LUM50 T13	500mm	560mm	
		LUM60 T13	600mm	560mm	
Tall - 2297mm high		LUT30 T13	300mm	560mm	
		LUT50 T13	500mm	560mm	
		LUT60 T13	600mm	560mm	
 <p>Type 14 Larder Unit 2 Doors (1 x varies acc to unit ht) (1 x 1245mm High) 2 Pull-out storage 3 Internal drawers</p>	Low - 1973mm high	LUL30 L or R (-) T14	300mm	560mm	
		LUL50 L or R (-) T14	500mm	560mm	
		LUL60 L or R (-) T14	600mm	560mm	
	Medium - 2117mm high	LUM30 L or R (-) T14	300mm	560mm	
		LUM50 L or R (-) T14	500mm	560mm	
		LUM60 L or R (-) T14	600mm	560mm	
	Tall - 2297mm high	LUT30 L or R (-) T14	300mm	560mm	
		LUT50 L or R (-) T14	500mm	560mm	
		LUT60 L or R (-) T14	600mm	560mm	
 <p>Type 15 Larder Unit 2 Doors (1 x varies acc to unit ht) (1 x 1245mm High) 5 Drawers (Low) 6 Drawers (Med/Tall)</p>	Low - 1973mm high	LUL30 L or R (-) T15	300mm	560mm	
		LUL50 L or R (-) T15	500mm	560mm	
		LUL60 L or R (-) T15	600mm	560mm	
	Medium - 2117mm high	LUM30 L or R (-) T15	300mm	560mm	
		LUM50 L or R (-) T15	500mm	560mm	
		LUM60 L or R (-) T15	600mm	560mm	
	Tall - 2297mm high	LUT30 L or R (-) T15	300mm	560mm	
		LUT50 L or R (-) T15	500mm	560mm	
		LUT60 L or R (-) T15	600mm	560mm	
 <p>Type 16 Larder Unit 2 Doors (1 x varies acc to unit ht) (1 x 1245mm High) 4 Internal drawers</p>	Low - 1973mm high	LUL30 L or R (-) T16	300mm	560mm	
		LUL50 L or R (-) T16	500mm	560mm	
		LUL60 L or R (-) T16	600mm	560mm	
	Medium - 2117mm high	LUM30 L or R (-) T16	300mm	560mm	
		LUM50 L or R (-) T16	500mm	560mm	
		LUM60 L or R (-) T16	600mm	560mm	
	Tall - 2297mm high	LUT30 L or R (-) T16	300mm	560mm	
		LUT50 L or R (-) T16	500mm	560mm	
		LUT60 L or R (-) T16	600mm	560mm	

SECTION  
4

# BUILT UNDER & WALL APPLIANCE HOUSING

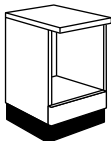
## BUILT UNDER APPLIANCE HOUSING

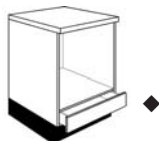
Model/Description	Product Code	Width	Depth Excluding Door
<b>Base Unit for Built Under Oven</b>			
Note: Check appliance manufacturer's ventilation requirements before fitting			
 Aperture: H600 x W563mm	<b>BUOH60</b> •	600mm	560mm
 Aperture: H600 x W863mm 1 Fixed panel	<b>BUOH90</b>	900mm	560mm
 Aperture: H600 x W563mm 1 Working Drawer (116 x 596)	<b>BDUOH60</b>	600mm	560mm

## WALL APPLIANCE AND BOILER HOUSING

### Wall Unit for Built-in Microwave

Note: Check appliance manufacturer's ventilation requirements before fitting

 720mm High open wall unit Aperture: H362 x W463mm	<b>WMMH50</b> (-)	500mm	300mm   350mm(D)
 720mm High wall unit with flap Aperture: H375.5 x W563mm 1 H284 x W596mm flap 1 H36 x W596mm stainless steel filler	<b>WMMHF60</b> (-)	600mm	300mm   350mm(D)
 900mm High open wall unit with 1 shelf Aperture: H362 x W463mm	<b>WTMH50</b> (-)	500mm	300mm   350mm(D)
 900mm High wall unit with 1 shelf and door Aperture: H385.5 x W563mm 1 H490mm x W596mm door	<b>WTMHF60</b> L or R (-)	600mm	300mm   350mm(D)

### Wall Boiler Housing

Note: Check boiler manufacturer's installation and ventilation requirements before fitting

 Wall boiler housing 720mm high 460mm deep to scribe as required Two ends, top and bottom panel and door Supplied ready to assemble Door not drilled for hinges	<b>WMBH60</b> •	600mm	460mm
 Wall boiler housing 900mm high 460mm deep to scribe as required Two ends, top and bottom panel and door Supplied ready to assemble Door not drilled for hinges	<b>WTBH60</b>	600mm	460mm

SECTION  
4

# 1492MM HIGH EURO APPLIANCE HOUSING

## EURO APPLIANCE HOUSING - 1492MM HIGH (INC. 150MM LEG HEIGHT)

Model/Description	Product Code	Width	Depth Excluding Door
-------------------	--------------	-------	----------------------

### 3/4 Euro Single Oven Housing

Note: Check appliance manufacturer's ventilation requirements before fitting

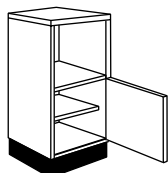

1 Bottom door (716 x 596)  
1 Adjustable shelf  
Aperture: H603.5 x W563mm

OHE60 L or R T27 Type 27 ●

600mm

560mm

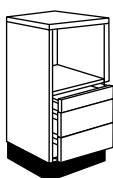

1 Drawer (140 x 596)  
2 Pan drawers (284 x 596)  
Aperture: H603.5 x W563mm

OHE60UT29 Type 29 ●

600mm

560mm



### 3/4 Euro Double Oven Housing

Note: Check appliance manufacturer's ventilation requirements before fitting

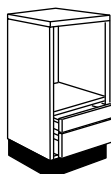

1 Drawer (140 x 596)  
1 Pan drawer (284 x 596)  
Aperture: H890.5 x W563mm

OHE60UT36 Type 36 ●

600mm

560mm



### 3/4 Euro Single Oven and Microwave Housing

Note: Check appliance manufacturer's ventilation requirements before fitting

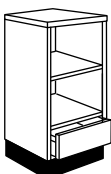

1 Pan drawer (284 x 596)  
1 Movable shelf  
Top aperture: H426.5 x W563mm  
Lower aperture: H591 x W563mm

OHE60UT32 Type 32 ●

600mm

560mm



### 3/4 Euro Integrated Microwave/Coffee Machine Housing

Note: Check appliance manufacturer's ventilation requirements before fitting

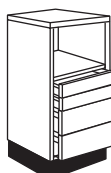

2 Drawers (140 x 596)  
2 Pan drawers (284 x 596)  
Aperture: H458.5 x W563mm

OHE60UT66 Type 66

600mm

560mm



SECTION 4 - EURO APPLIANCE HOUSING - 1492MM HIGH

SECTION  
4

# 1492MM HIGH EURO APPLIANCE HOUSING

## EURO APPLIANCE HOUSING - 1492MM HIGH (INC. 150MM LEG HEIGHT)

Model/Description	Product Code	Width	Depth Excluding Door
-------------------	--------------	-------	----------------------

### 3/4 Euro Integrated Microwave/Coffee Machine Housing

Note: Check appliance manufacturer's ventilation requirements before fitting

 <p>1 Filler panel (65 x 596) 2 Drawers (140 x 596) 2 Pan drawers (284 x 596) Aperture: H389.5 x W563mm *Note: 65 filler only available in certain ranges, if not available stainless steel will be supplied</p> <p>★</p>	<p><b>OHE60UT67</b> Type 67</p>	<p>600mm</p>	<p>560mm</p>
 <p>1 Drawer (140 x 596) 1 Door (716 x 596) 1 Adjustable shelf Aperture: H458.5 x W563mm</p> <p>★</p>	<p><b>OHE60</b> L or R T68 Type 68</p>	<p>600mm</p>	<p>560mm</p>

### 3/4 Euro Integrated Microwave Housing

 <p>1 Filler (65 x 596) 1 Drawer (140 x 596) 1 Door (716 x 596) 1 Adjustable shelf Aperture: H389.5 x W563mm *Note: 65mm filler only available in certain ranges, if not available stainless steel will be supplied</p> <p>★</p>	<p><b>OHE60</b> L or R T71 Type 71</p>	<p>600mm</p>	<p>560mm</p>
---	--	--------------	--------------

### 3/4 Euro Integrated Fridge or Freezer Housing

Note: Check appliance manufacturer's ventilation requirements before fitting

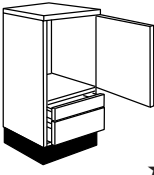
 <p>1 Door (896 x 596) 1 Drawer (140 x 596) 1 Pan drawer (284 x 596) Aperture: H890.5 x W563mm</p> <p>★</p>	<p><b>FHE60</b> L or R T33 Type 33</p>	<p>600mm</p>	<p>560mm</p>
	<p><b>FHE60UT33</b> (Undrilled)</p>	<p>600mm</p>	<p>560mm</p>

### 3/4 Euro Integrated Fridge or Freezer and Microwave Housing

Note: Check appliance manufacturer's ventilation requirements before fitting

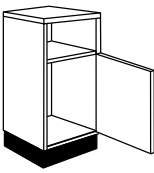
 <p>1 Door (896 x 596) 1 Movable shelf Top aperture: H409 x W563mm Lower aperture: H878 x W563mm</p>	<p><b>FHE60</b> L or R T35 Type 35</p>	<p>600mm</p>	<p>560mm</p>
	<p><b>FHE60UT35</b> (Undrilled)</p>	<p>600mm</p>	<p>560mm</p>

SECTION  
4

# 1973MM HIGH LOW APPLIANCE HOUSING

## LOW APPLIANCE HOUSING - 1973MM HIGH (INC. 150MM LEG HEIGHT)

Model/Description	Product Code	Width	Depth Excluding Door
-------------------	--------------	-------	----------------------

### Single Oven Housing

For use with 576mm high Wall Units. Note: Check appliance manufacturer's ventilation requirements before fitting

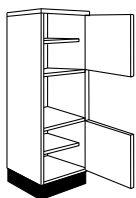

2 Doors (490 x 596, 716 x 596)  
2 Adjustable shelves  
Aperture: H609 x W563mm

OHL60 L or R T1 Type 1

600mm

560mm

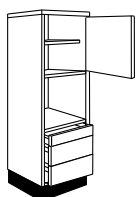

1 Top door (490 x 596)  
1 Drawer (140 x 596)  
2 Pan drawers (284 x 596)  
1 Adjustable shelf  
Aperture: H609 x W563mm

OHL60 L or R T3 Type 3

600mm

560mm



### Double Oven Housing

For use with 576mm high Wall Units. Note: Check appliance manufacturer's ventilation requirements before fitting

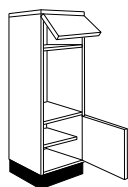

1 Top flap door (340 x 596)  
1 Bottom door (572 x 596)  
1 Adjustable shelf  
Aperture: H901 x W563mm

OHL60 L or R T6 Type 6

600mm

560mm

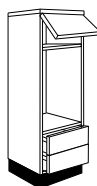

1 Top flap door (340 x 596)  
2 Pan drawers (284 x 596)  
Aperture: H901 x W563mm

OHL60UT7 Type 7

600mm

560mm



### Single Oven and Microwave Housing

For use with 576mm high Wall Units. Note: Check appliance manufacturer's ventilation requirements before fitting

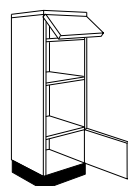

1 Top flap door (284 x 596)  
1 Door (450 x 596)  
1 Movable shelf  
Top aperture: H474 x W563mm  
Lower aperture: H591 x W563mm

OHL60 L or R T13 Type 13

600mm

560mm

SECTION 4 - LOW APPLIANCE HOUSING - 1973MM HIGH

SECTION  
4

# 1973MM HIGH LOW APPLIANCE HOUSING

## LOW APPLIANCE HOUSING - 1973MM HIGH (INC. 150MM LEG HEIGHT)

Model/Description	Product Code	Width	Depth Excluding Door
-------------------	--------------	-------	----------------------

### Single Oven and Microwave Housing

For use with 576mm high Wall Units. Note: Check appliance manufacturer's ventilation requirements before fitting

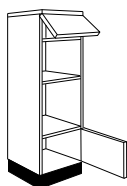

1 Top flap door (340 x 596)  
1 Door (450 x 596)  
1 Movable shelf  
Top aperture: H422 x W563mm  
Lower aperture: H591 x W563mm

**OHL60** L or R T16 Type 16

600mm

560mm

### Double Oven and Microwave Housing

For use with 576mm high Wall Units. Note: Check appliance manufacturer's ventilation requirements before fitting

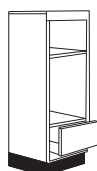

1 Fixed drawer front (140 x 596)  
1 Pan drawer (284 x 596)  
1 Movable shelf  
Top aperture: H462 x W563mm  
Lower aperture: H901 x W563mm

**OHL60UT28** Type 28

600mm

560mm

★

### Integrated Microwave Housing

Note: Check appliance manufacturer's ventilation requirements before fitting

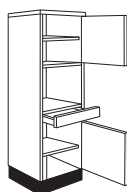

1 Door (572 x 596)  
1 Drawer (140 x 596)  
1 Door (716 x 596)  
2 Adjustable shelves  
Aperture: H380 x W563mm  
Clearance: H389

**OHL60** L or R T50 Type 50

600mm

560mm

★

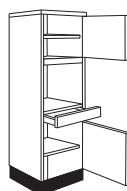

1 Door (490 x 596)  
1 Filler (65 x 596)  
1 Drawer (140 x 596)  
1 Door (716 x 596)  
2 Adjustable shelves  
Aperture: H397 x W563mm  
Clearance: H402  
\*Note: 65mm filler only available in certain ranges, if not available stainless steel will be supplied

**OHL60** L or R T58 Type 58

600mm

560mm

★

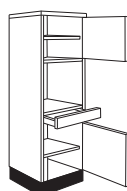

1 Door (490 x 596)  
1 Drawer (140 x 596)  
1 Door (716 x 596)  
2 Adjustable shelves  
Aperture: H462 x W563mm  
Clearance: H471

**OHL60** L or R T54 Type 54

600mm

560mm

★

SECTION 4 - LOW APPLIANCE HOUSING - 1973MM HIGH

SECTION  
4

# 1973MM HIGH LOW APPLIANCE HOUSING

## LOW APPLIANCE HOUSING - 1973MM HIGH (INC. 150MM LEG HEIGHT)

Model/Description	Product Code	Width	Depth Excluding Door
-------------------	--------------	-------	----------------------

### Integrated Microwave and Steam Oven Housing

Note: Check appliance manufacturer's ventilation requirements before fitting

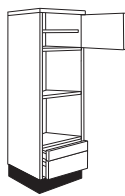
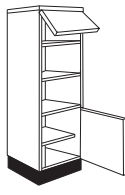
	<p>1 Door (450 x 596) 1 Drawer (140 x 596) 1 Pan drawer (284 x 596) 1 Adjustable shelf 1 Movable shelf Top aperture: H470 x W563mm Bottom aperture: H450 x W563mm Clearance: H943</p>	<p><b>OHL60</b> L or R T59 Type 59</p>	<p>600mm</p>	<p>560mm</p>
	<p>1 Flap (284 x 596) 1 Door (670 x 596) 1 Adjustable shelf 1 Movable shelf Top aperture: H394 x W563mm Bottom aperture: H450 x W563mm Clearance: H867</p>	<p><b>OHL60</b> L or R T60 Type 60</p>	<p>600mm</p>	<p>560mm</p>

### Integrated Fridge or Freezer Housing

For use with 576mm high Wall Units. Note: Check appliance manufacturer's ventilation requirements before fitting  
Hinges not supplied on undrilled housings. Handles sent loose

	<p>1 Top flap door (340 x 596) 2 Doors (896 x 596, 572 x 596) 1 Adjustable shelf Aperture: H891 x W563mm</p>	<p><b>FHL60</b> L or R T19 Type 19</p>	<p>600mm</p>	<p>560mm</p>
		<p><b>FHL60U</b> L or R T19 (Undrilled)</p>	<p>600mm</p>	<p>560mm</p>
	<p>3 Doors (340 x 596, 572 x 596, 896 x 596) Removable shelf for use with combi Top aperture: H886.5 x W563mm Lower aperture: H881.5 x W563mm</p>	<p><b>FHL60</b> L or R T23 Type 23</p>	<p>600mm</p>	<p>560mm</p>
		<p><b>FHL60UT23</b> (Undrilled)</p>	<p>600mm</p>	<p>560mm</p>
	<p>2 Doors (572 x 596, 1245 x 596) 1 Adjustable shelf Aperture: H1224 x W563mm</p>	<p><b>FHL60</b> L or R T27 Type 27</p>	<p>600mm</p>	<p>560mm</p>
		<p><b>FHL60U</b> L or R T27 (Undrilled)</p>	<p>600mm</p>	<p>560mm</p>

### Universal Housing Carcase

Order doors separately, see page 114. Supplied dry assembled (drilling for shelves to be done on site)

For use with 576mm high Wall Units. Note: Check appliance manufacturer's ventilation requirements before fitting

	<p>3 Full depth 'fixed' shelves 3 Adjustable shelves 1 Full back panel (to cut as required)</p>	<p><b>OHL60</b></p>	<p>600mm</p>	<p>560mm</p>
---	---	---------------------	--------------	--------------

# 2117MM HIGH MEDIUM APPLIANCE HOUSING

## MEDIUM APPLIANCE HOUSING - 2117MM HIGH (INC. 150MM LEG HEIGHT)

Model/Description

Product Code

Width

Depth Excluding Door

### Single Oven Housing

For use with 720mm high Wall Units. Note: Check appliance manufacturer's ventilation requirements before fitting

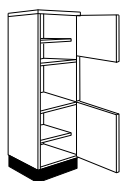

2 Doors (644 x 596, 716 x 596)  
2 Adjustable shelves  
Aperture: H609 x W563mm

OHM60 L or R T1 Type 1

600mm

560mm

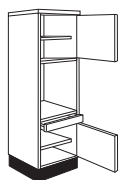

2 Doors (490 x 596, 716 x 596)  
1 Drawer (140 x 596)  
2 Adjustable shelves  
Aperture: H601 x W563mm

OHM60 L or R T2 Type 2

600mm

560mm

★

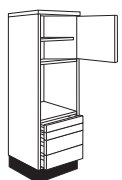

1 Door (490 x 596)  
2 Drawer fronts (140 x 596)  
2 Pan drawers (284 x 596)  
1 Adjustable shelf  
Aperture: H601 x W563mm

OHM60 L or R T4 Type 4

600mm

560mm

★

### Double Oven Housing

For use with 720mm high Wall Units. Note: Check appliance manufacturer's ventilation requirements before fitting

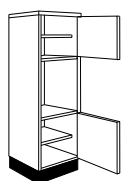

2 Doors (490 x 596, 572 x 596)  
2 Adjustable shelves  
Aperture: H899 x W563mm

OHM60 L or R T6 Type 6

600mm

560mm

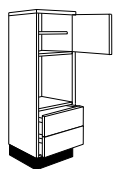

1 Top door (490 x 596)  
2 Pan drawers (284 x 596)  
1 Adjustable shelf  
Aperture: H899 x W563mm

OHM60 L or R T7 Type 7

600mm

560mm

★

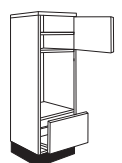

1 Door (490 x 596)  
1 Door (572 x 596)  
1 Pull-out storage  
1 Internal drawer  
1 Adjustable shelf  
Aperture: H898 x W563mm  
Clearance: H903

OHM60 L or R T43 Type 43

600mm

560mm

◆

# 2117MM HIGH MEDIUM APPLIANCE HOUSING

## MEDIUM APPLIANCE HOUSING - 2117MM HIGH (INC. 150MM LEG HEIGHT)

Model/Description

Product Code

Width

Depth Excluding Door

### Single Oven and Microwave Housing

For use with 720mm high Wall Units. Note: Check appliance manufacturer's ventilation requirements before fitting

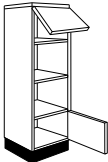
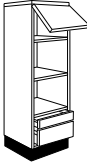
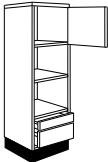
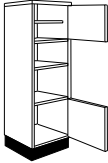
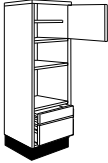
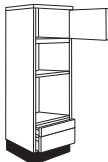
 <p>1 Top flap door (284 x 596) 1 Door (450 x 596) 1 Movable shelf Top aperture: H618 x W563mm Lower aperture: H591 x W563mm Available for use with two single ovens or single oven and 450mm microwave plus 140mm warming drawer</p>	OHM60 L or R T10 Type 10	600mm	560mm
 <p>1 Top flap door (284 x 596) 1 Drawer (140 x 596) 1 Pan drawer (284 x 596) 1 Movable shelf Top aperture: H618 x W563mm Lower aperture: H591 x W563mm Available for use with two single ovens or single oven and 450mm microwave plus 140mm warming drawer</p> <p>★</p>	OHM60UT11 Type 11	600mm	560mm
 <p>1 Door (450 x 596) 1 Drawer (140 x 596) 1 Pan drawer (284 x 596) 1 Adjustable shelf 1 Movable shelf Top aperture: H474 x W563mm Lower aperture: H590 x W563mm</p> <p>★</p>	OHM60 L or R T14 Type 14	600mm	560mm
 <p>2 Doors (490 x 596, 450 x 596) 1 Adjustable shelf 1 Movable shelf Top aperture: H412 x W563mm Lower aperture: H591 x W563mm</p>	OHM60 L or R T16 Type 16	600mm	560mm
 <p>1 Top door (490 x 596) 1 Drawer (140 x 596) 1 Pan drawer (284 x 596) 1 Adjustable shelf 1 Movable shelf Top aperture: H412 x W563mm Lower aperture: H591 x W563mm</p> <p>★</p>	OHM60 L or R T17 Type 17	600mm	560mm
 <p>1 Door (450 x 596) 1 Filler (65 x 596) 1 Drawer (140 x 596) 1 Pan drawer (284 x 596) 1 Movable shelf Top aperture: H405 x W563mm Bottom aperture: H590 x W563mm Clearance: H1018</p> <p>★</p>	OHM60 L or R T63 Type 63	600mm	560mm

SECTION  
4

# 2117MM HIGH MEDIUM APPLIANCE HOUSING

## MEDIUM APPLIANCE HOUSING - 2117MM HIGH (INC. 150MM LEG HEIGHT)

Model/Description	Product Code	Width	Depth Excluding Door
-------------------	--------------	-------	----------------------

### Double Oven and Microwave Housing

For use with 720mm high Wall Units. Note: Check appliance manufacturer's ventilation requirements before fitting

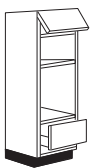
	<ul style="list-style-type: none"> <li>1 Door (340 x 596)</li> <li>1 Drawer (140 x 596)</li> <li>1 Drawer (176 x 596)</li> <li>1 Movable shelf</li> <li>Top aperture: H392 x W563mm</li> <li>Bottom aperture: H890 x W563mm</li> <li>Clearance: H1305</li> </ul>	<b>OHM60UT64</b> Type 64	600mm	560mm
	<ul style="list-style-type: none"> <li>1 Flap (284 x 596)</li> <li>1 Pan drawer (284 x 596)</li> <li>1 Movable shelf</li> <li>Top aperture: H484 x W563mm</li> <li>Lower aperture: H890 x W563mm</li> <li>36mm Filler in stainless steel only</li> </ul>	<b>OHM60UT28</b> Type 28	600mm	560mm

### Integrated Microwave Housing

Note: Check appliance manufacturer's ventilation requirements before fitting

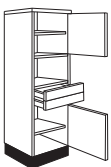
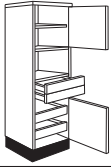
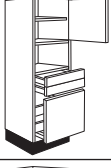
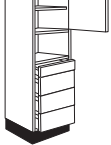
	<ul style="list-style-type: none"> <li>1 Door (572 x 596)</li> <li>2 Drawers (140 x 596)</li> <li>1 Door (716 x 596)</li> <li>2 Adjustable shelves</li> <li>Aperture: H380 x W563mm</li> <li>Clearance: H389</li> </ul>	<b>OHM60</b> L or R T50 Type 50	600mm	560mm
	<ul style="list-style-type: none"> <li>1 Door (572 x 596)</li> <li>2 Drawers (140 x 596)</li> <li>1 Door (716 x 596)</li> <li>2 Internal drawers</li> <li>1 Adjustable shelf</li> <li>Aperture: H380 x W563mm</li> <li>Clearance: H389</li> </ul>	<b>OHM60</b> L or R T51 Type 51	600mm	560mm
	<ul style="list-style-type: none"> <li>1 Door (572 x 596)</li> <li>2 Drawers (140 x 596)</li> <li>1 Door (716 x 596)</li> <li>1 Pull-out storage</li> <li>2 Internal drawers</li> <li>1 Adjustable shelf</li> <li>Aperture: H380 x W563mm</li> <li>Clearance: H389</li> </ul>	<b>OHM60</b> L or R T52 Type 52	600mm	560mm
	<ul style="list-style-type: none"> <li>1 Door (572 x 596)</li> <li>1 Drawer (140 x 596)</li> <li>3 Pan drawers (284 x 596)</li> <li>1 Adjustable shelf</li> <li>Aperture: H380 x W563mm</li> <li>Clearance: H389</li> </ul>	<b>OHM60</b> L or R T53 Type 53	600mm	560mm

### Integrated Microwave or Coffee Machine Housing

Note: Check appliance manufacturer's ventilation requirements before fitting

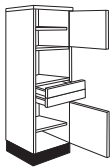
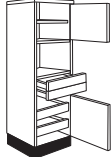
	<ul style="list-style-type: none"> <li>1 Door (490 x 596)</li> <li>2 Drawers (140 x 596)</li> <li>1 Door (716 x 596)</li> <li>2 Adjustable shelves</li> <li>Aperture: H466 x W563mm</li> <li>Clearance: H471</li> </ul>	<b>OHM60</b> L or R T54 Type 54	600mm	560mm
	<ul style="list-style-type: none"> <li>1 Door (490 x 596)</li> <li>2 Drawers (140 x 596)</li> <li>1 Door (716 x 596)</li> <li>2 Internal drawers</li> <li>1 Adjustable shelf</li> <li>Aperture: H466 x W563mm</li> <li>Clearance: H471</li> </ul>	<b>OHM60</b> L or R T55 Type 55	600mm	560mm

SECTION  
4



# 2117MM HIGH MEDIUM APPLIANCE HOUSING

## MEDIUM APPLIANCE HOUSING - 2117MM HIGH (INC. 150MM LEG HEIGHT)

Model/Description	Product Code	Width	Depth Excluding Door
-------------------	--------------	-------	----------------------

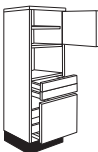

### Integrated Microwave or Coffee Machine Housing

Note: Check appliance manufacturer's ventilation requirements before fitting

 ★ ◆	1 Door (490 x 596). 2 Drawers (140 x 596) 1 Door (716 x 596) 1 Pull-out storage 2 Internal drawers 1 Adjustable shelf Aperture: H466 x W563mm Clearance: H471	<b>OHM60 L or R T56 Type 56</b>	600mm	560mm
 ★	1 Door (490 x 596) 1 Drawer (140 x 596) 3 Pan drawers (284 x 596) 1 Adjustable shelf Aperture: H466 x W563mm Clearance: H471	<b>OHM60 L or R T57 Type 57</b>	600mm	560mm

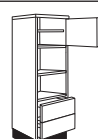

### Integrated Microwave/Steam Oven Housing/Coffee Machine

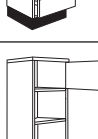
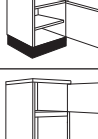
Note: Check appliance manufacturer's ventilation requirements before fitting

 ★	1 Door (450 x 596) 1 Door (450 x 596) 1 Movable Shelf 1 Adjustable shelf Top aperture: H457 x W563mm Bottom aperture: H588 x W563mm	<b>OHM60 L or R T13 Type 13</b>	600mm	560mm
 ★	1 Door (450 x 596) 2 Pan drawers (284 x 596) 1 Movable shelf Top aperture: H470 x W563mm Bottom aperture: H450 x W563mm Clearance: H943	<b>OHM60 L or R T59 Type 59</b>	600mm	560mm
 ★	1 Door (450 x 596). 1 Filler (65 x 596) 2 Pan drawers (284 x 596). 1 Movable shelf Top aperture: H401 x W563mm Bottom aperture: H450 x W563mm Clearance: H874 Note: 65mm filler is available in selected ranges, where not available stainless steel will be supplied	<b>OHM60 L or R T61 Type 61</b>	600mm	560mm
 ★	1 Door (450 x 596) 1 Door (572 x 596) 1 Adjustable shelf 1 Movable shelf Top aperture: H470 x W563mm Bottom aperture: H450 x W563mm Clearance: H943	<b>OHM60 L or R T62 Type 62</b>	600mm	560mm
 ★	1 Door (450 x 496). 1 Filler (65 x 596) 1 Door (572 x 596). 1 Movable shelf 1 Adjustable shelf. Top aperture: H401 x W563mm Bottom aperture: H450 x W563mm Clearance: H874 Note: 65mm filler is available in selected ranges, where not available stainless steel will be supplied	<b>OHM60 L or R T60 Type 60</b>	600mm	560mm

### Integrated Fridge or Freezer Housing

For use with 720mm high Wall Units. Note: Check appliance manufacturer's ventilation requirements before fitting

 ◆	3 Doors (490 x 596, 896 x 596, 572 x 596) 2 Adjustable shelves Aperture: H891 x W563mm	<b>FHM60 L or R T19 Type 19</b>	600mm	560mm
		<b>FHM60U L or R T19 (Undrilled)</b>	600mm	560mm
 ★ ◆	2 Doors (490 x 596, 896 x 596) 2 Pan drawers (284 x 596) 1 Adjustable shelf Aperture: H891 x W563mm	<b>FHM60 L or R T20 Type 20</b>	600mm	560mm
		<b>FHM60U L or R T20 (Undrilled)</b>	600mm	560mm

SECTION  
4

# 2117MM HIGH MEDIUM APPLIANCE HOUSING

## MEDIUM APPLIANCE HOUSING - 2117MM HIGH (INC. 150MM LEG HEIGHT)

Model/Description	Product Code	Width	Depth Excluding Door
-------------------	--------------	-------	----------------------

### Integrated Fridge Freezer Housing

For use with 720mm high Wall Units. Note: Check appliance manufacturer's ventilation requirements before fitting  
Hinges not supplied on undrilled housings. Handles sent loose

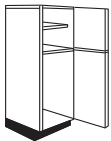
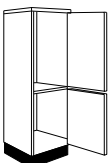
 <p>❖</p> <p>2 Doors (716 x 596, 1245 x 596) 1 Adjustable shelf Aperture: H1224 x W563mm</p>	<b>FHM60</b> L or R T27 Type 27	600mm	560mm
	<b>FHM60U</b> L or R T27 (Undrilled)	600mm	560mm
 <p>❖</p> <p>2 Doors (1065 x 596, 896 x 596) Top aperture: H1030.5 x W563mm Lower aperture: H881.5 x W563mm Removable shelf for use with combi fridge freezer</p>	<b>FHM60</b> L or R T23 Type 23	600mm	560mm
	<b>FHM60U</b> T23 (Undrilled)	600mm	560mm

### Integrated Combi Fridge or Freezer Housing

For use with 720mm high Wall Units. Note: Check appliance manufacturer's ventilation requirements before fitting

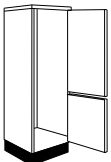
 <p>❖</p> <p>2 Doors (1245 x 596, 716 x 596) 4 Removable shelves Aperture: H1930 x W563mm</p>	<b>FHM60</b> L or R T24 Type 24	600mm	560mm
	<b>FHM60U</b> T24 (Undrilled)	600mm	560mm

### Integrated Fridge or Freezer and Microwave Housing

For use with 720mm high Wall Units. Note: Check appliance manufacturer's ventilation requirements before fitting

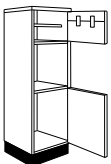
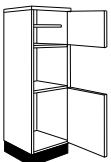
 <p>❖</p> <p>3 Doors (140 x 596, 490 x 596, 896 x 596) 1 Adjustable shelf 1 Movable shelf Microwave aperture: H413 x W563mm Fridge or freezer aperture: H881.5 x W563mm</p>	<b>FHM60</b> L or R T25 Type 25	600mm	560mm
	<b>FHM60U</b> L or R T25 (Undrilled)	600mm	560mm
 <p>❖</p> <p>2 Doors (572 x 596, 896 x 596) 1 Adjustable shelf 1 Movable shelf Microwave aperture: H475 x W563mm Fridge or freezer aperture: H881.5 x W563mm</p>	<b>FHM60</b> L or R T26 Type 26	600mm	560mm
	<b>FHM60U</b> L or R T26 (Undrilled)	600mm	560mm

### Universal Housing Carcase

Order doors separately, see page 114. Supplied dry assembled (drilling for shelves to be done on site)  
For use with 720mm high Wall Units. Note: Check appliance manufacturer's ventilation requirements before fitting

 <p>❖</p> <p>3 Full depth 'fixed' shelves 3 Adjustable shelves 1 Full back panel (to cut as required)</p>	<b>OHMC60</b>	600mm	560mm
--	---------------	-------	-------

# 2297MM HIGH TALL APPLIANCE HOUSING

## TALL APPLIANCE HOUSING - 2297MM HIGH (INC. 150MM LEG HEIGHT)

Model/Description

Product Code

Width

Depth Excluding Door

### Single Oven Housing

For use with 900mm high Wall Units. Note: Check appliance manufacturer's ventilation requirements before fitting

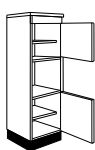

1 Fixed drawer front (140 x 596)  
2 Doors (670 x 596, 716 x 596)  
2 Adjustable shelves  
Aperture: H609 x W563mm

OHT60 L or R T1 Type 1

600mm

560mm

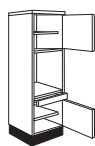

2 Doors (670 x 596, 716 x 596)  
1 Drawer front (140 x 596)  
2 Adjustable shelves  
Aperture: H601 x W563mm

OHT60 L or R T2 Type 2

600mm

560mm

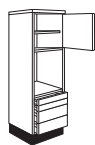

1 Door (670 x 596)  
2 Drawer fronts (140 x 596)  
2 Pan drawers (284 x 596)  
1 Adjustable shelf  
Aperture: H601 x W563mm

OHT60 L or R T4 Type 4

600mm

560mm

### Double Oven Housing

For use with 900mm high Wall Units. Note: Check appliance manufacturer's ventilation requirements before fitting

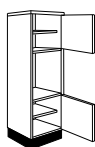

2 Doors (670 x 596, 572 x 596)  
2 Adjustable shelves  
Aperture: H901 x W563mm

OHT60 L or R T6 Type 6

600mm

560mm

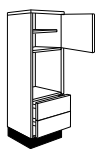

1 Top door (670 x 596)  
2 Pan drawers (284 x 596)  
1 Adjustable shelf  
Aperture: H901 x W563mm

OHT60 L or R T7 Type 7

600mm

560mm

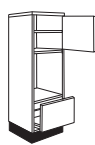

1 Door (670 x 596), 1 Door (572 x 596)  
1 Pull-out storage  
1 Internal drawer  
1 Adjustable shelf  
Aperture: H898 x W563mm  
Clearance: H903

OHT60 L or R T43 Type 43

600mm

560mm

### Single Oven and Microwave Housing

For use with 900mm high Wall Units. Note: Check appliance manufacturer's ventilation requirements before fitting

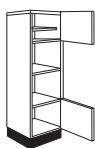

2 Doors (450 x 596)  
1 Adjustable shelf  
1 Movable shelf  
Top aperture: H605.5 x W563mm  
Lower aperture: H605.5 x W563mm  
Available for use with two single ovens or single oven and 450mm appliance with 140mm warming drawer

OHT60 L or R T10 Type 10

600mm

560mm

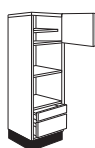

1 Top door (450 x 596), 1 Drawer (140 x 596)  
1 Pan drawer (284 x 596)  
1 Adjustable shelf  
1 Movable shelf  
Top aperture: H605.5 x W563mm  
Lower aperture: H605.5 x W563mm  
Available for use with two single ovens or single oven and 450mm appliance with 140mm warming drawer

OHT60 L or R T11 Type 11

600mm

560mm

# 2297MM HIGH TALL APPLIANCE HOUSING

## TALL APPLIANCE HOUSING - 2297MM HIGH (INC. 150MM LEG HEIGHT)

Model/Description

Product Code

Width

Depth Excluding Door

### Single Oven and Microwave Housing

For use with 900mm high Wall Units. Note: Check appliance manufacturer's ventilation requirements before fitting



2 Doors (490 x 596, 572 x 596)  
2 Adjustable shelves  
1 Movable shelf  
Top aperture: H470 x W563mm  
Lower aperture: H595 x W563mm

OHT60 L or R T13 Type 13

600mm

560mm

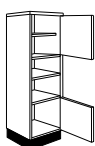

2 Doors (670 x 596, 450 x 596)  
1 Adjustable shelf  
1 Movable shelf  
Top aperture: H422 x W563mm  
Lower aperture: H591 x W563mm

OHT60 L or R T16 Type 16

600mm

560mm

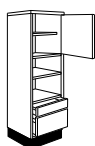

1 Top door (670 x 596)  
1 Drawer (140 x 596)  
1 Pan drawer (284 x 596)  
1 Adjustable shelf  
1 Movable shelf  
Top aperture: H434 x W563mm  
Lower aperture: H591 x W563mm

★

OHT60 L or R T17 Type 17

600mm

560mm

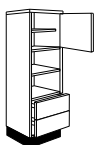

1 Top door (490 x 596)  
2 Pan drawers (284 x 596)  
1 Adjustable shelf  
1 Movable shelf  
Top aperture: H470 x W563mm  
Lower aperture: H590 x W563mm

★

OHT60 L or R T36 Type 36

600mm

560mm



1 Door (490 x 596), 1 Door (572 x 596)  
1 Pull-out storage, 1 Internal drawer  
1 Movable shelf  
1 Adjustable shelf  
Top aperture: H470 x W563mm  
Bottom aperture: H590 x W563mm  
Clearance: H1083

◆

OHT60 L or R T44 Type 44

600mm

560mm



1 Door (572 x 596)  
2 Pan drawers (284 x 596)  
1 Movable shelf  
1 Adjustable shelf  
Top aperture: H388 x W563mm  
Bottom aperture: H590 x W563mm  
Clearance: H1001

★

OHT60 L or R T63 Type 63

600mm

560mm



2 Doors (572 x 596)  
1 Movable shelf  
2 Adjustable shelves  
Top aperture: H388 x W563mm  
Bottom aperture: H590 x W563mm  
Clearance: H1001

OHT60 L or R T65 Type 65

600mm

560mm

### Double Oven and Microwave Housing

Note: Check appliance manufacturer's ventilation requirements before fitting



1 Door (490 x 596)  
1 Pan drawer (284 x 596)  
1 Movable shelf  
Top aperture: H458 x W563mm  
Bottom aperture: H890 x W563mm  
Clearance: H1366

★

OHT60 L or R T28 Type 28

600mm

560mm

# 2297MM HIGH TALL APPLIANCE HOUSING

## TALL APPLIANCE HOUSING - 2297MM HIGH (INC. 150MM LEG HEIGHT)

Model/Description

Product Code

Width

Depth Excluding Door

### Double Oven and Microwave Housing

Note: Check appliance manufacturer's ventilation requirements before fitting



★

1 Door (490 x 596). 1 Filler (65 x 596)  
1 Pan drawer (284 x 596)  
1 Movable shelf. 1 Adjustable shelf  
Top aperture: H389 x W563mm  
Bottom aperture: H890 x W563mm  
Clearance: H1302

OHT60 L or R T64 Type 64

600mm

560mm

### Integrated Microwave Housing

Note: Check appliance manufacturer's ventilation requirements before fitting

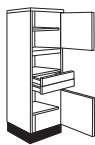

★

1 Door (670 x 596). 1 Filler (65 x 596)  
2 Drawers (140 x 596). 1 Door (716 x 596)  
2 Adjustable shelves. Aperture: H397 x W563mm  
Clearance: H405  
\*Note: 65mm filler only available in certain ranges,  
if not available stainless steel will be supplied

OHT60 L or R T50 Type 50

600mm

560mm



★

1 Door (670 x 596). 1 Filler (65 x 596)  
2 Drawers (140 x 596). 1 Door (716 x 596)  
2 Internal drawers. 1 Adjustable shelf  
Aperture: H397 x W563mm. Clearance: H405  
\*Note: 65mm filler only available in certain ranges,  
if not available stainless steel will be supplied

OHT60 L or R T51 Type 51

600mm

560mm

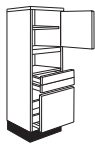

★

◆

1 Door (670 x 596). 1 Filler (65 x 596)  
2 Drawers (140 x 596). 1 Door (716 x 596)  
1 Pull-out storage. 2 Internal drawers  
1 Adjustable shelf. Aperture: H397 x W563mm  
Clearance: H405  
\*Note: 65mm filler only available in certain ranges,  
if not available stainless steel will be supplied

OHT60 L or R T52 Type 52

600mm

560mm

### Integrated Microwave and Coffee Machine Housing

Note: Check appliance manufacturer's ventilation requirements before fitting

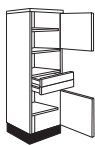

★

1 Door (670 x 596)  
2 Drawers (140 x 596)  
1 Door (716 x 596)  
2 Adjustable shelves  
Aperture: H466 x W563mm  
Clearance: H471

OHT60 L or R T54 Type 54

600mm

560mm



★

1 Door (670 x 596)  
2 Drawers (140 x 596)  
1 Door (716 x 596)  
2 Internal drawers  
1 Adjustable shelf  
Aperture: H466 x W563mm  
Clearance: H471

OHT60 L or R T55 Type 55

600mm

560mm



★

◆

1 Door (670 x 596). 2 Drawers (140 x 596)  
1 Door (716 x 596). 1 Pull-out storage  
2 Internal drawers  
1 Adjustable shelf  
Aperture: H466 x W563mm  
Clearance: H471

OHT60 L or R T56 Type 56

600mm

560mm



★

1 Door (490 x 596). 1 Drawer (140 x 596)  
2 Pan drawers (284 x 596). 1 Movable shelf  
1 Adjustable shelf  
Top aperture: H466 x W563mm  
Bottom aperture: H450 x W563mm  
Clearance: H939

OHT60 L or R T59 Type 59

600mm

560mm



1 Door (490 x 596). 1 Filler (65 x 596)  
1 Door (716 x 596). 1 Movable shelf.  
2 Adjustable shelves. Top aperture: H397 x W563mm  
Bottom aperture: H450 x W563mm. Clearance: H870  
\*Note: 65mm filler only available in certain ranges,  
if not available stainless steel will be supplied

OHT60 L or R T60 Type 60

600mm

560mm

SECTION  
4

# 2297MM HIGH TALL APPLIANCE HOUSING

## TALL APPLIANCE HOUSING - 2297MM HIGH (INC. 150MM LEG HEIGHT)

Model/Description	Product Code	Width	Depth Excluding Door
-------------------	--------------	-------	----------------------

### Integrated Microwave and Coffee Machine Housing

Note: Check appliance manufacturer's ventilation requirements before fitting

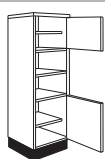

1 Door (490 x 596)  
1 Door (716 x 596)  
1 Movable shelf  
2 Adjustable shelves  
Top Aperture: H466 x W563mm  
Bottom Aperture: H450 x W563mm  
Clearance: H939

OHT60 L or R T62 Type 62

600mm

560mm

### Integrated Fridge or Freezer Housing

For use with 900mm high Wall Units. Note: Check appliance manufacturer's ventilation requirements before fitting

Hinges not supplied on undrilled housings. Handles sent loose

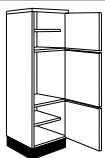

3 Doors (670 x 596, 896 x 596, 572 x 596)  
2 Adjustable shelves  
Aperture: H891 x W563mm

FHT60 L or R T19 Type 19

600mm

560mm

FHT60U L or R T19 (Undrilled)

600mm

560mm



2 Doors (670 x 596, 896 x 596)  
2 Pan drawers (284 x 596)  
1 Adjustable shelf  
Aperture: H891 x W563mm

FHT60 L or R T20 Type 20

600mm

560mm

FHT60U L or R T20 (Undrilled)

600mm

560mm

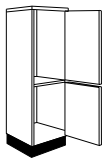

2 Doors (1245 x 596, 896 x 596)  
Top aperture: H1210.5 x W563mm  
Lower aperture: H881.5 x W563mm  
Removable shelf for use with combi fridge freezer

FHT60 L or R T23 Type 23

600mm

560mm

FHT60U T23 (Undrilled)

600mm

560mm

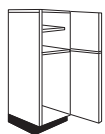

2 Doors (896 x 596, 1245 x 596)  
1 Adjustable shelf  
Aperture: H1224 x W563mm

FHT60 L or R T27 Type 27

600mm

560mm

FHT60U T27 (Undrilled)

600mm

560mm

### Integrated Combi Fridge Freezer Housing

For use with 900mm high Wall Units. Note: Check appliance manufacturer's ventilation requirements before fitting

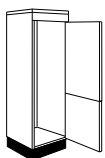

2 Doors (1245 x 596, 716 x 596)  
1 Dummy drawer front (140 x 596)  
1 MFC Filler rail (40mm high)  
Aperture: H1929 x W563mm

FHT60 L or R T24 Type 24

600mm

560mm

FHT60U T24 (Undrilled)

600mm

560mm

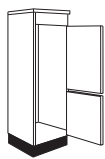

1 Door (716 x 596)  
1 Door (1245 x 596)  
1 Dummy drawer (176 x 596)  
Aperture: H1952 x W563mm

FHT60 L or R T75 Type 75

600mm

560mm

FHT60U T75 (Undrilled)

600mm

560mm

### Universal Housing Carcase Order doors separately. See page 114

For use with 900mm high Wall Units. Supplied dry assembled



3 Full depth 'fixed' shelves  
3 Adjustable shelves  
1 Full back panel (to cut as required)

OHTC60

600mm

560mm

SECTION 4 - TALL APPLIANCE HOUSING - 2297MM HIGH

## Option 1 - Free-Standing Appliances

The simplest way of designing a Contact kitchen is to use free-standing appliances whilst avoiding certain units – e.g. pull-out units, magic corners, etc. Any unit that requires a handle will be clearly identified within the Directory.

Avoid pull-outs and wirework

Light pelmet cannot be fitted under bi-fold units



Use free-standing fridges/freezers

Use free-standing washing machine and dishwasher

## Option 1 - Free-Standing Appliances

The second way of designing a Contact kitchen is to order certain appliance doors and units with a face fixed handle. These are highlighted in the Directory and recommended handle suites are 110, 119, 121 and 142.

Handle on pull-outs/wirework

Light pelmet cannot be fitted under bi-fold units

Handle on magic corner unit

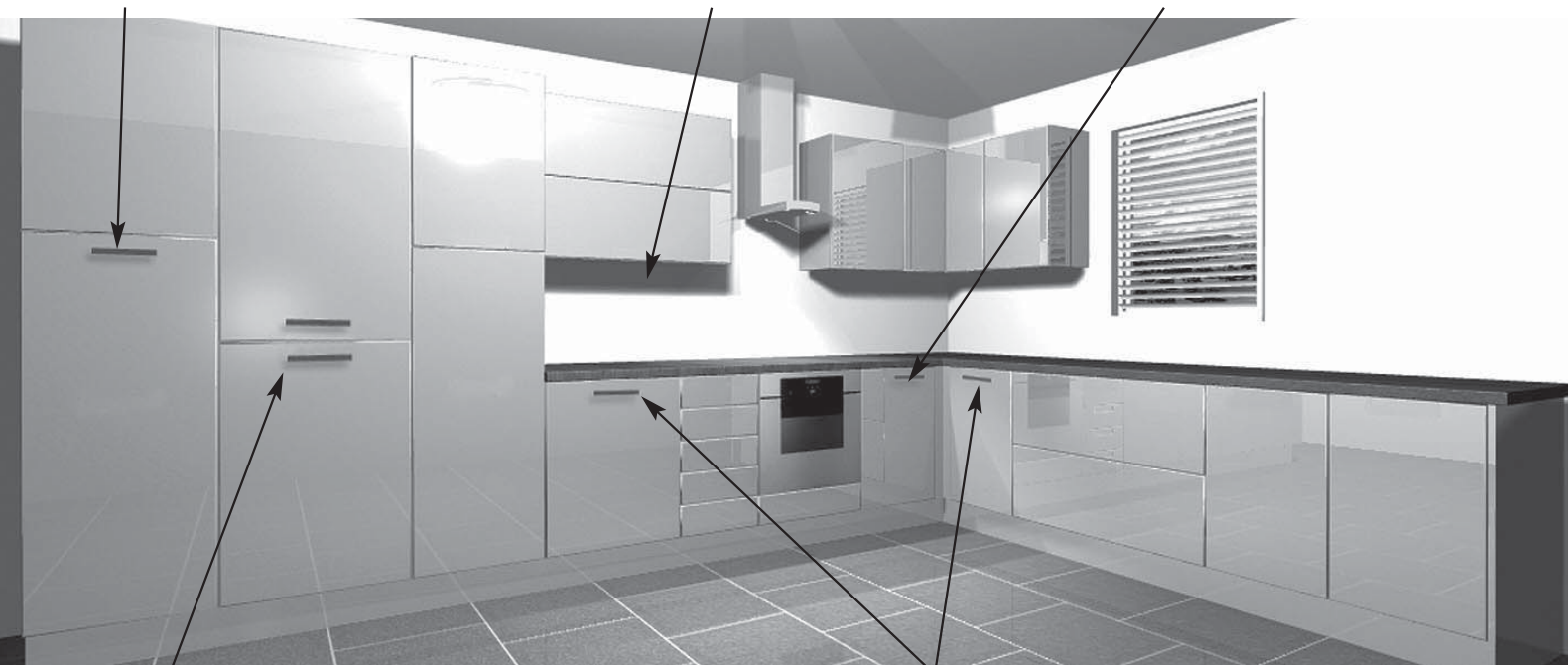

Handles on fridge-freezer housing

Handle on integrated washing machine and dishwasher (or use a click open integrated dishwasher e.g. Smeg)

# Option 3 – Aluminium Extrusion

The third way of designing a Contact kitchen is to fit worktop extrusion to the base units which lifts the worktop by 30mm. 30mm vertical extrusions are used between tall units.

Certain appliance doors and units need to be ordered with handle Suite 201 with the extrusions providing a recess which allows access to the handle.  
(Note: Curved base units cannot be fitted with the worktop extrusion.)

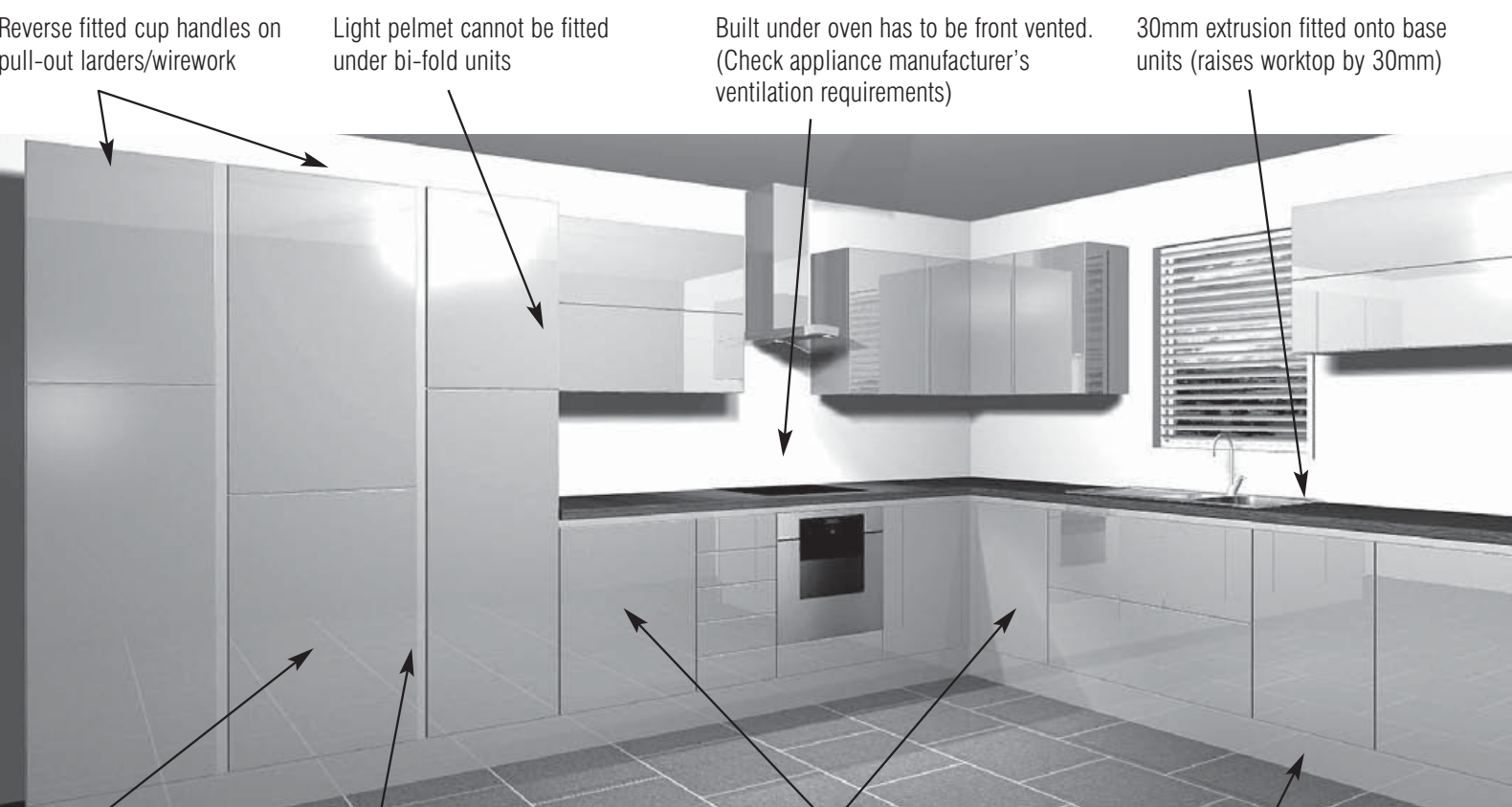

Reverse fitted cup handles on pull-out larders/wirework

Light pelmet cannot be fitted under bi-fold units

Built under oven has to be front vented. (Check appliance manufacturer's ventilation requirements)

30mm extrusion fitted onto base units (raises worktop by 30mm)

Handle suite 201 fitted to fridge freezer housing

30mm vertical extrusion fitted between units Code: PHL2500LD See page opposite.

Handle suite 201 on integrated washing machine and dishwasher (or use a click open dishwasher e.g. Smeg)

Reduce plinth height by 30mm if required (by ordering units on 100mm legs and winding legs up by 20mm)



Aluminium extrusion fitted horizontally below worktop Code: PHL3500WT See page opposite.



Suite 201 – Units that require this handle are marked with ❖

## CONTACT HANDLELESS EXTRUSION KITS

Model/Description

Product Code

### Contact Worktop Extrusion Kit

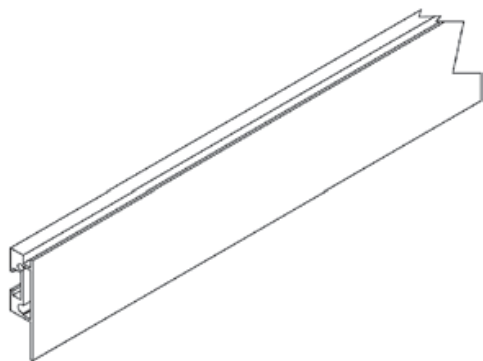

Kit includes:  
1 x 3500mm Extrusion  
10 x Fixing clips  
5 x Worktop spacers  
1 x roll of sealing strip 6000mm

**PHL3500WT**

### Contact Worktop Extrusion Kit – End Piece

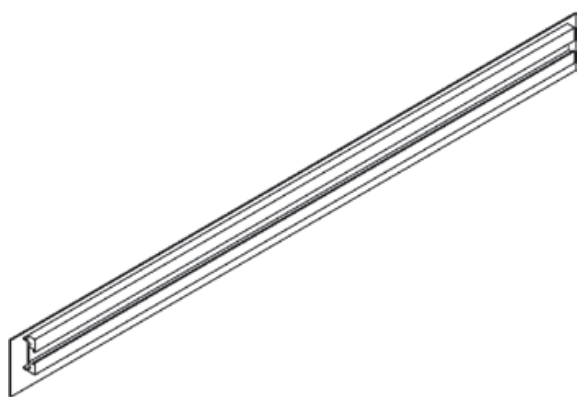

VAT Charged at Standard Rate For use at the end of a run of base units – trim one end as required

For use on island units where an 890mm add-on panel is used at each end

**PHL829END**

### Contact Worktop Extrusion Kit – Island End Piece

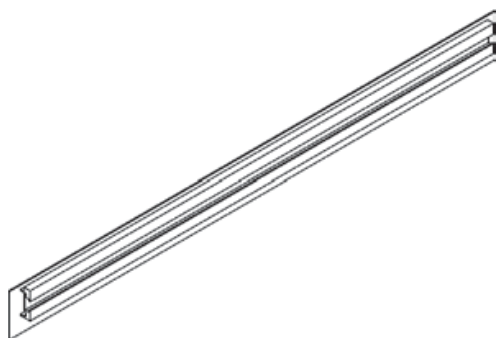

For use on island units where a 596mm add-on panel is used at each end

**PHL555END**

### Contact Vertical Extrusion Kit



Kit includes:  
1 x 2500mm extrusion  
8 x Fixing clips  
4 x Spacers

**PHL2500LD**

**Contact Base Unit Extrusion Fixing**

Touch Base Unit  
Extrusion Fixing

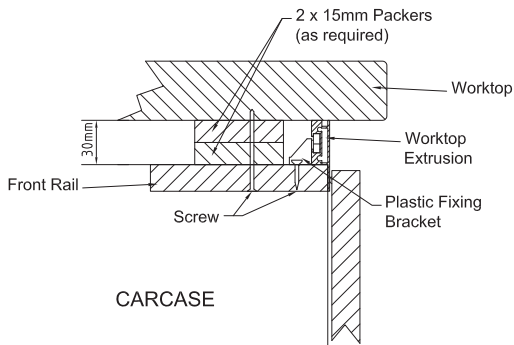

**Contact Tall Unit Extrusion Fixing**

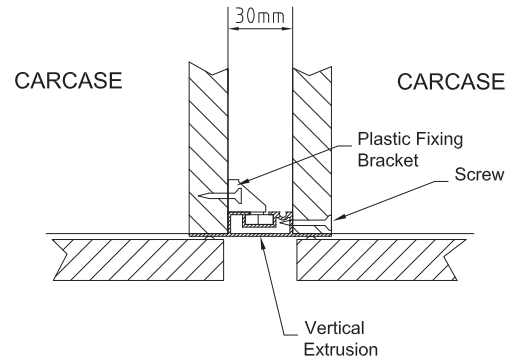

Touch Tall Unit  
Extrusion Fixing

**Contact Worktop Spacers**

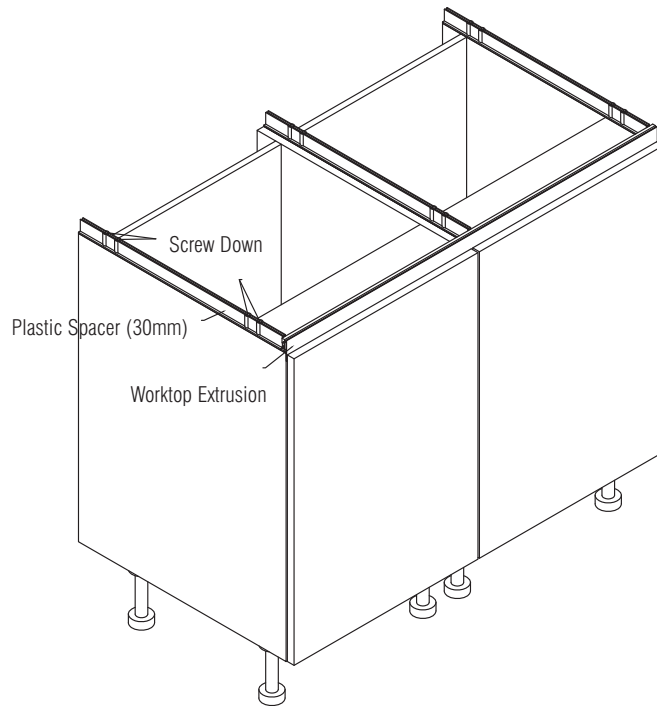

**Contact Drawer Runners**

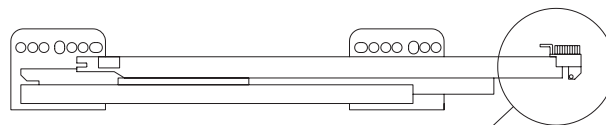

To adjust the gap between the drawer front and the front of the carcass, use a coin to turn the adjustment screw at the back of the runner.

A gap of approximately 4mm is required to activate the 'Contact' mechanism.

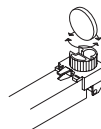

### Contact 926mm Island Unit Extrusion Fixing

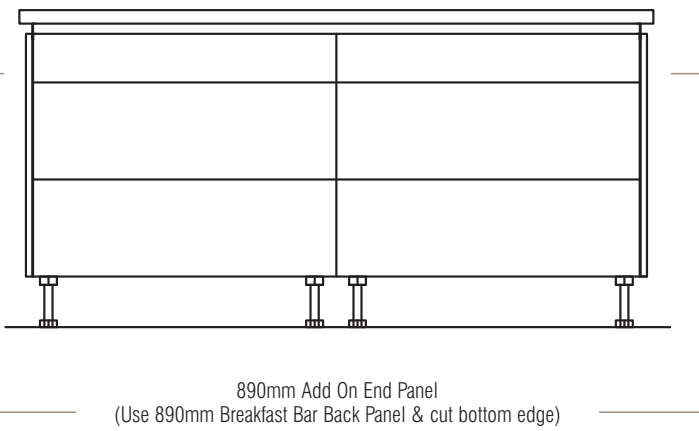
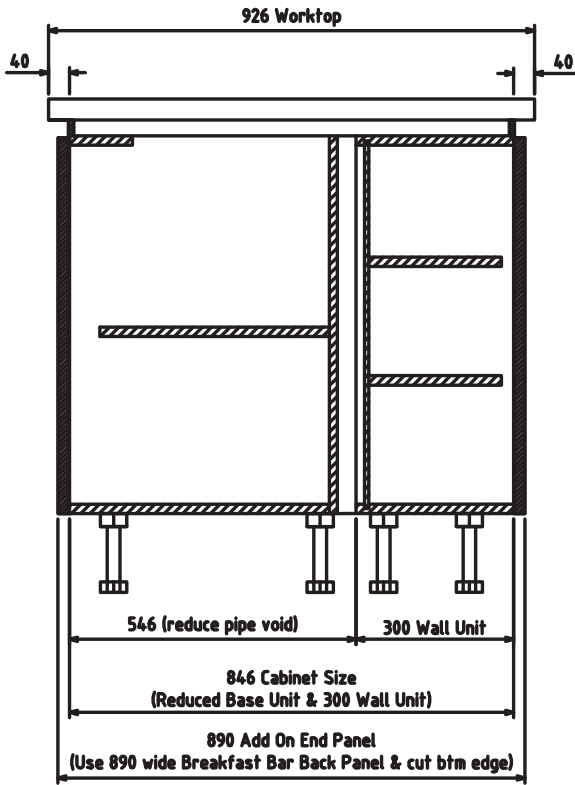

### Contact 632mm Island Unit Extrusion Fitting

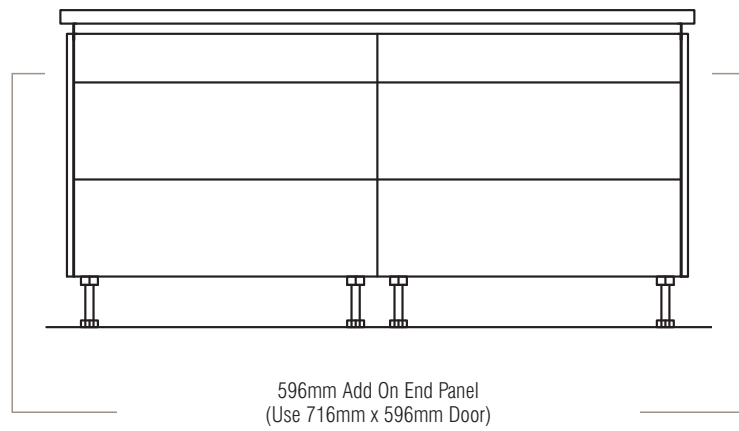
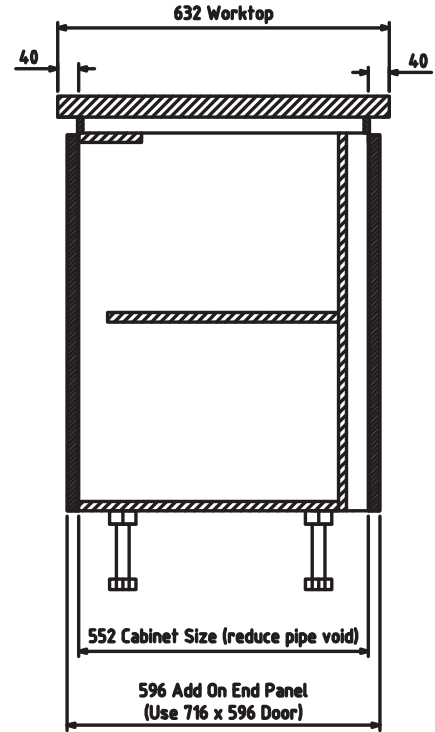

## Handle Options For Appliance Housings/Fascias, Pull-Out Units and Magic Corner Units

Any units that require a handle, such as appliance housings, appliance fascias, pull-out units and magic corner units, are clearly marked in the Directory with the following symbols:

- ❖ Select from handle suite 201 (for use with aluminium extrusions) or face fixed handle suites 110, 119, 121, 142
- ◆ Select from face fixed handle suites 110, 119, 121, 142

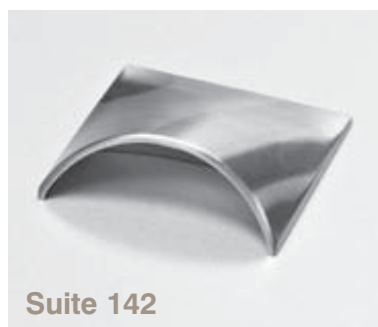
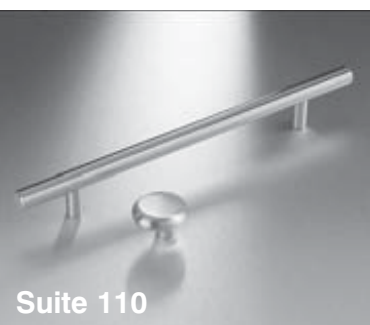

Suite 201 has been specifically designed to work with 'Contact' kitchens when aluminium extrusions are used.

This handle can be fitted simply, on-site, and enables the individual to pull open the units specified above, whilst not intruding on the handlefree design.

